



TUŠ KABINE

SHOWER ENCLOSURES



04

Dinamika tuš kabine

Za tuš kabino se odločamo zaradi hitrega tempa življenja, pomanjkanja prostora, manjše porabe vode in manjšega odtisa na okolje. Tuš kabine Kolpasan nam pomagajo kopalnico prostorsko čimbolje izkoristiti, optično povečati, pa tudi vsakodnevno lažje čistiti.

Tuš kabine
Shower enclosures
Tuš kabine
Tuš kabine

Dynamics of shower enclosure

We opt for a shower enclosure due to the fast pace of life, lack of space, lower water consumption and lower footprint on the environment. Kolpasan shower enclosures help us make the most of the bathroom, optically enlarge it, and facilitate daily cleaning.

Dinamika tuš kabine

Za tuš kabinu se odločujemo zbog brzog tempa života, manjka prostora, manje potrošnje vode i manjeg utjecaja na okoliš. Tuš kabine Kolpasan pomažu nam da što bolje iskoristimo svoju kupaonice, optički je povećamo i olakšamo svakodnevno čišćenje.

Dinamika tuš kabine

Za tuš-kabinu se odločujemo zbog brzog tempa života, nedovoljno prostora, manje potrošnje vode i manjeg uticaja na okolinu. Tuš-kabine Kolpasan nam pomažu da što bolje iskoristimo svoje kupatilo, da ga optički povećamo i olakšamo svakodnevno čišćenje.





04

116





TUŠ KABINE SHOWER ENCLOSURES TUŠ KABINE TUŠ KABINE



• možnosti izbire med različnimi vrstami stekel in profilov

- select between different types of glass and profiles
- možnost izbora između različnih vrsta stakla i profila
- mogućnost odabira između različnih vrsta stakla i profila



• sodobno oblikovane tuš kabine čistih oblik z robustno konstrukcijo

- modern designed shower enclosures with pure geometric shapes
- moderno dizajnirane tuš kabine čistih oblika s robustno konstrukcijom
- moderan dizajn tuš-kabine sa čistim oblikom i čvrstom konstrukcijom



• naši izdelki omogočajo različne možnosti vgradnje

- our products offer different options of installation
- naši proizvodi omogočajo različite možnosti ugradnje
- naši proizvodi omogočavaju različite možnosti postavljanja

10

• več kot 10 družin tuš kabin za opremo najrazličnejših vrst kopalnic

- more than 10 models of shower enclosures for the equipment of a wide range of bathrooms
- više od 10 modela tuš kabina za opremo raznih vrsta kupaonica
- više od 10 modela tuš kabina za opremanje različitih vrsta kupatila



• možnost prilagajanja oblike pri določenih modelih

- possibility of adjusting the shape at certain models
- mogućnost prilagođavanja oblika određenih modela
- mogućnost prilagođavanja oblika određenih modela



• možnost izvedbe nestandardni dimenzij z dodatnimi kompenzacijskimi profili

- possibility of implementing non-standard dimensions with additional compensation profiles
- mogućnost izvedbe nestandardnih dimenzija s dodatnim kompenzacijskim profilima
- mogućnost izvođenja nestandardnih dimenzija sa dodatnim kompenzacionim profilima



Legenda

Legend
Legenda
Legenda

118



Vrste tuš kabin: | Types of shower enclosures: | Vrste tuš kabina: | Vrste tuš kabina:

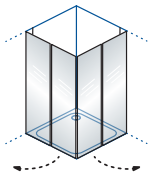

Q
- kvadratna, krilna
- square, winged
- kvadratna, klizna
- kvadratna, spoljašnje otvaranje vrata

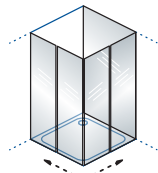

Q | TKK
- kvadratna, drsna
- square, sliding
- kvadratna, klizna
- kvadratna, klizna

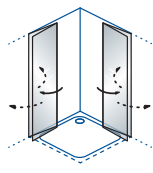

Q
- kvadratna, zložljiva
- square, folding
- kvadratna, sklopiva
- kvadratna, sklopiva

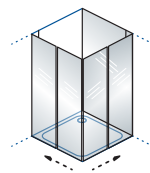

D+ D + WU
- kvadratna, drsna, + stena
- square, sliding + wall
- kvadratna, klizna + stijena
- kvadratna, klizna + stena

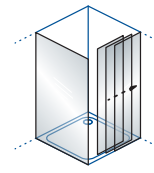

TV3D/S + TSv
- drsna vrata + stena
- sliding door + wall
- klizna vrata + stijena
- klizna vrata + stena

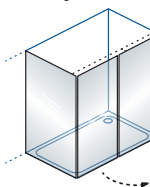

D + W
- krilna vrata + stena
- winged door + wall
- krilata vrata + stijena
- krilata vrata + stena

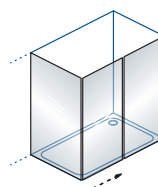

D + W | DW | TK
- drsna vrata + stena
- sliding door + wall
- klizna vrata + stijena
- klizna vrata + stena

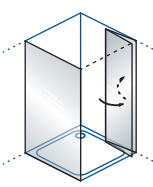

D + W | TVZ/S + TSvZ
- zložljiva vrata + stena
- folding door + wall
- sklopiva vrata + stijena
- sklopiva vrata + stena

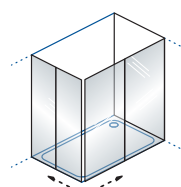

D + D
- vrata + vrata, drsna
- door + door, sliding
- vrata + vrata, klizna
- vrata + vrata, klizna

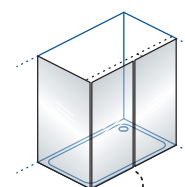

DW
- drsna rotirajuća vrata + stena
- sliding-rotating door + wall
- klizno-rotirajuća vrata + stijena
- klizno-rotirajuća vrata + stena

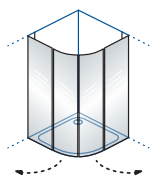

R
- polkrožna, krilna
- semi-circular, winged
- polukružna, klizna
- polukružna, spoljašnje otvaranje vrata

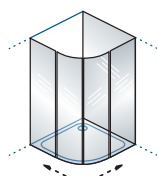

R | TKP
- polkrožna, drsna
- semi-circular, sliding
- polukružna, klizna
- polukružna, klizna

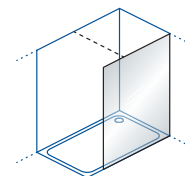

WO
- tuš stena - open
- shower wall - open
- tuš stijena - open
- tuš stena - open

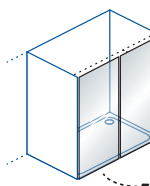

N
- niša, krilna
- niche, winged
- niša, klizna
- niša, spoljašnje otvaranje vrata

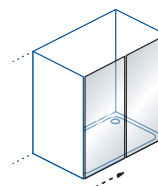

N | TV2D/S
- niša, drsna
- niche, sliding
- niša, klizna
- niša, klizna

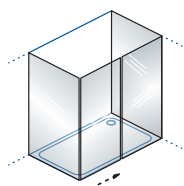

N + 2x WU
- niša, drsna + 2 steni
- niche, sliding + 2 walls
- niša, klizna + 2 stijene
- niša, klizna + 2 stene

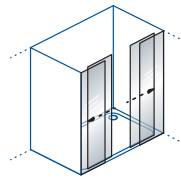

N
- niša, 4 delna, drsna
- niche, 4 part, sliding
- niša, 4 dijelna, klizna
- niša, 4 delna, klizna

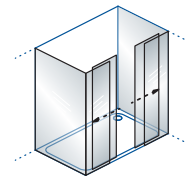

N + 2x WU
- niša, 4 delna, drsna + 2 steni
- niche, 4 part, sliding + 2 walls
- niša, 4 dijelna, klizna + 2 stijene
- niša, 4 delna, klizna + 2 stene

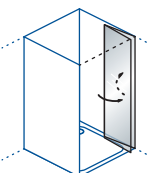

N
- niša, zložljiva
- niche, folding
- niša, sklopiva
- niša, sklopiva

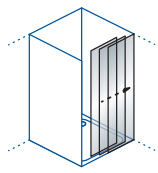

TV3D/S
- niša, drsna
- niche, sliding
- niša, klizna
- niša, klizna

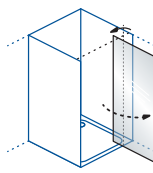

TVO/S
- niša, obračalna
- niche, turnable
- niša, okretna
- niša, okretna

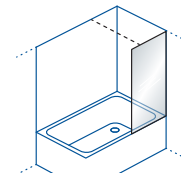

BS (TP)
- krilni zaslon
- bathtub screen
- paravan
- paravan

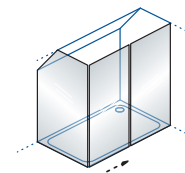

- po meri
- custom made
- po narudžbi
- po meri

Info



Legenda

Legend
Legenda
Legenda



Barva profila: | Profile colour: | Boja profila: | Boja profila:



Gold (GLD)
Gold (GLD)
Gold (GLD)
Gold (GLD)



Silver Brill (SBR)
Silver Brill (SBR)
Silver Brill (SBR)
Silver Brill (SBR)



Black (B)
Black (B)
Black (B)
Black (B)



Silver (S)
Silver (S)
Silver (S)
Silver (S)



Bela (WH)
White (WH)
Bijela (WH)
Bela (WH)



debelina stekla
glass thickness
deblina stakla
deblina stakla



višina profilov
height of profiles
visina profila
visina profila



Vrste stekla: | Types of glass: | Vrste stakla: | Vrste stakla:



kaljeno prozorno steklo (1)
tempered transparent glass
kaljeno prozirno staklo
kaljeno providno staklo



kaljeno chincilla steklo (2)
tempered chinchilla glass
kaljeno chincilla staklo
kaljeno chincilla staklo



graphite kaljeno steklo (3)
graphite tempered glass
graphite kaljeno staklo
graphite kaljeno staklo



mirror steklo (5)
mirror glass
mirror staklo
mirror staklo

Opcije: | Options: | Opcije: | Opcije:



zapiranje z magnetnim profilom
magnetic closure
zatvaranje s magnetnim profilom
zatvaranje pomoću magnetnog profila



tečaji z dvizno funkcijo
hinges with lifting function
panti s podiznom funkcijom
šarke sa funkcijom podizanja



opora za stabilnost tuš kabine
support for the stability
of the shower enclosure
potpora za stabilnost tuš kabine
oslonac za stabilnost tuš kabine



dodatni aluminijasti profil na tuš kadi
preprečuje iztekanje vode
an additional shower door threshold
prevents overflow
dodatni aluminijasti profil na tuš kadi
sprečava istjecanje vode
dodatni aluminijumski profil na tuš kadi
sprečava izlivanje vode



Clean coat, zaštitni premaz
Clean coat, protective coating
Clean coat, zaštitni premaz
Clean coat, zaštitni premaz



snemljiva vratna krila
omogočajo lažje čiščenje
detachable door panels for easier cleaning
vratna krila na skidanje
omogućuju lakše čišćenje
vratna krila sa mogućnošću
skidanja omogućavaju lakše čišćenje



drsno-rotirajoča vrata, omogočajo veliko
vhodno odprtino
sliding-rotating doors, allowing a large entrance
opening
klizna-rotirajuća vrata, omogućujući veliki ulazni otvor
klizna-rotirajuća vrata, omogućava veliki ulazni otvor



demontažni pokrov
demounting cover
demontažni poklopac
demontažni poklopac



možnost kompenzacijskih profilov
the possibility of compensation profiles
mogućnost kompenzacijskih profila
mogućnost kompenzacionih profila



držalo za brisače
towel holder
držač ručnika
držač za peškire



mirror steklo (8 mm)
mirror glass (8 mm)
mirror staklo (8 mm)
mirror staklo (8 mm)



tuš kabina po meri
custom shower cabin
tuš kabina po mjeri
tuš kabina po mjeri

Dimenzije: | Dimensions: | Dimenzije: | Dimenzije:



L1, L2

vgradna mera na tuš kad
inbuilt dimension on shower trays
ugradbena mjera na tuš kadu
ugradna mera na tuš kadu



X1, X2

vgradna mera na tla (ploščice)
inbuilt dimension on floor (tiles)
ugradbena mjera na podu (ploščice)
ugradna mera na podu (ploščice)



E

vhodna odprtina
entrance
ulazni otvor
ulazni otvor



višina
height
visina
visina



radij
radius
polumjer
radijus



Faktorji vodotesnosti tuš kabin po modelih

Factors affecting water tightness of shower cabins according to models

Čimbenici vodonepropusnosti tuš kabina po modelima

Faktori koji utiču na vodonepropusnost tuš kabina u zavisnosti od modela

Kljub tesnilom na tuš kabini voda še vedno izteka. Je to normalno?

Despite the sealants on my shower enclosure, water still leaks. Is this normal?

Unatoč brtvilima na tuš kabini voda još uvijek otječe. Je li normalno?

Bez obzira na zaptivke na tuš kabini voda i dalje curi. Da li je to normalno?

Tuš kabine ponujajo različne stopnje vodotesnosti, vendar popolne zaščite proti uhajanju vode ni mogoče zagotoviti.

Shower enclosures come in various levels of water resistance. However, nobody can ensure total protection against water leakage.

Tuš kabine nude različite stupnjeve brtvljenja, ali potpunu zaštitu od otjecanja vode nije moguće osigurati.

Tuš kabine nude različite nivoe zaptivanja, ali se potpuna zaštita od curenja vode ne može obezbediti.

F 1

Faktor 1

Modeli tuš kabin v izvedbi z aluminijastim okvirjem

Ti modeli omogočajo posebno dobre vodotesne lastnosti. Priporočajo se za prhanja z večjo frekvenco in uporabo masažnih prh z veliko količino vode.

Factor 1

Shower cabin enclosures featuring an aluminium frame

These models feature particularly good water tightness characteristics and are recommended for more frequent showers and use of massage showers consuming large quantities of water.

Čimbenik 1

Modeli tuš kabina u izvedbi s aluminijemskim okvirom

Ti modeli omogućuju posebno dobra vodonepropusna svojstva. Preporučuju se za tuširanja s većom frekvencijom i uporabom masažnih tuševa s velikom količinom vode.

Faktor 1

Modeli tuš kabina u izvedbi sa aluminijumskim okvirom

Ti modeli omogućavaju posebno dobre osobine u pogledu zaptivanja. Preporučuju se za tuširanja sa većom frekvencijom i korišćenje masažnih tuševa sa velikom količinom vode.

Kabine s spodnjim okvirjem
Enclosures with the bottom frame
Kabine s donjim okvirom
Kabine sa donjim okvirom



F 1

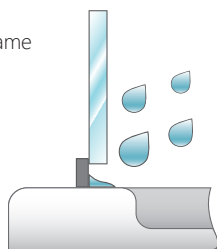

F 2

Faktor 2

Modeli tuš kabin z dodatnim zaščitnim profilom

Dodatno nameščen profil izboljšuje stopnjo zaščite vodotesnosti, vendar je ne more 100% zagotoviti.

Factor 2

Shower enclosures models with an additional protection profile

Additionally installed profile improves the water tightness protection level, but it cannot guarantee it 100%.

Čimbenik 2

Modeli tuš kabina s dodatnim zaštitnim profilom

Dodatno postavljen profil poboljšava stupanj zaštite vodonepropusnosti, ali ju ne može 100% osigurati.

Faktor 2

Modeli tuš kabina sa dodatnim zaštitnim profilom

Dodatno montiran profil poboljšava stepen zaštite u pogledu zaptivanja, ali ga ne može garantovati 100%.

Dodatni zaščitni profil
Additional protection profiles
Dodatni zaštitni profil
Dodatni zaštitni profil



F 2

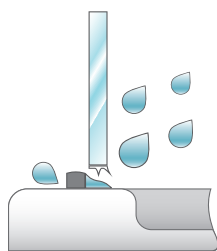

F 3

Faktor 3

Modeli tuš kabin v izvedbi brez aluminijastega okvirja

Imajo zadovoljivo stopnjo zaščite vodotesnosti. Zaradi manjkajočega spodnjega okvirja, ima voda možnost lažjega iztekanja. Kljub temu so ti modeli kabin elegantni, ekskluzivni in omogočajo lažje čiščenje.

Factor 3

Shower enclosures models without an aluminium frame

They provide a satisfactory water tightness protection level. Since the bottom frame is missing, water can more easily leak out. Nevertheless, these cabin models are elegant, exclusive and are easier to clean.

Čimbenik 3

Modeli tuš kabina u izvedbi bez aluminijemskog okvira

Imaju zadovoljavajući stupanj zaštite u smislu vodonepropusnosti. Zbog manjkajućega donjeg okvira voda ima mogućnost lakšega istjecanja. Unatoč tomu ti su modeli kabina elegantni, ekskluzivni i omogućuju lakše čišćenje.

Faktor 3

Modeli tuš kabina u izvedbi bez aluminijumskog okvira

Imaju zadovoljavajući stepen zaštite u pogledu zaptivanja. Zbog nepostojećeg donjeg okvira, voda ima mogućnost lakšeg otcjanja. Bez obzira na to, ti modeli kabina su elegantni, ekskluzivni i omogućavaju lakše čišćenje.

Kabine bez okvirja
Enclosures without a frame
Kabine bez okvira
Kabine bez okvira



F 3

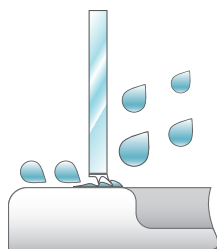

Design tuš zaslonov odreja stopnjo vodotesnosti. Osnovno pravilo je: čim večji in višji je spodnji profil, toliko je višja stopnja zaščite.

The design of the shower screens determines the water tightness. The basic rule: the larger and taller the middle profile, the higher the protection level.

Dizajni tuš zaslona određuju stupanj vodonepropusnosti. Osnovno je pravilo: što je veći i viši donji profil, toliko je viši stupanj zaštite.

Dizajn tuš paravana određuje stepen zaptivanja. Osnovno pravilo je: što je viši i veći donji profil, veći je i stepen zaštite.



Pogosta vprašanja - tuš kabine

FAQ - Shower Enclosures
Učestala pitanja - tuš kabine
Česta pitanja - tuš kabine



Katere prednosti prinaša zaščita stekel Clean Coat pri tuš kabinah?

What are the advantages of Clean Coat-protected glass for shower enclosures?

Koje prednosti donosi zaščita stakla Clean Coat a kod tuš kabina?

Koje prednosti donosi zaščita stakala Clean Coat kod tuš kabina?

Prednosti zaščite stekel tuš kabin:

- **estetske:** čist in svetleč izgled, ki traja dlje časa. Zaradi odpornosti proti umazaniji, madežem in potemnenju, se podaljša prvotni videz
- **funkcionalne:** omogoča zelo preprosto čiščenje
- **higijske:** omogoča hitrejšo splakovanje, ki odstrani umazanijo, sol in bakterije in za sabo ne pušča usedlin in ostankov. Če je steklena površina dlje časa izpostavljena vodi, olajša odstranitev usedle umazanije z večkratnim umivanjem.
- **ekološke:** manjša uporaba bolj agresivnih čistil

Advantages of shower enclosure glass-protection:

- **Aesthetics:** clean and shiny appearance that lasts longer; the resistance to dirt, stains and dark blotches prolongs its original appearance.
- **Functionality:** extremely easy to clean
- **Hygienic aspect:** enables faster rinsing, to remove dirt, salt and bacteria, and leaves no deposits and remains. If the glass is exposed to water for a longer period of time, it facilitates removal of deposited dirt through multiple washing.
- **Ecological aspect:** reduces use of more aggressive cleaning agents.



Prednosti zaščite stakala tuš kabina:

- **estetske:** čist i svjetleći izgled koji traje duže vremena. Zbog otpornosti na nečistoće, mrlje i tamnjenje produžuje se prvobitni izgled
- **funkcionalne:** omogućava vrlo jednostavno čišćenje
- **higijenske:** omogućava brže ispiranje koje uklanja nečistoće, sol i bakterije te za sobom ne ostavlja talog i ostatke. Ako je staklena površina duže vrijeme izložena vodi, olakšava uklanjanje nataložene nečistoće koja je nastala višekratnom uporabom.
- **ekološke:** manja potrošnja agresivnijih sredstava za čišćenje

Prednosti zaščite stakala tuš kabina:

- **estetske:** čist i sjajan izgled koji traje duže vreme. Zbog otpornosti na prljavštinu, fleke i potamnivanje prvobitni izgled duže traje
- **funkcionalne:** omogućava vrlo jednostavno čišćenje
- **higijenske:** omogućava brže ispiranje koje uklanja prljavštinu, so i bakterije i iza sebe ne ostavlja naslage i ostatke. Ukoliko je staklena površina duže vreme izložena vodi, olakšava uklanjanje naslaga prljavština višekratnim pranjem
- **ekološke:** manja potrošnja agresivnijih sredstava za čišćenje



Družine tuš kabin in njihove značilnosti

A range of shower enclosures and their characteristics

Skupine tuš-kabina i njihove karakteristike

Asortiman tuš kabina i njihove karakteristike



Polaris

> 127



Polaris fold

> 135



Andromeda UNI

> 141



Aquarius UNI

> 149

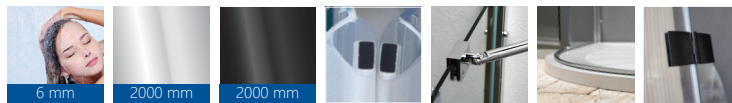

Calypso UNI

> 155

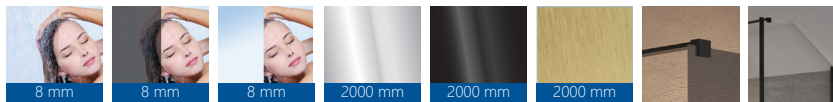

Libra

> 159



Virgo UNI

> 165



Stellar UNI

> 169

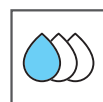
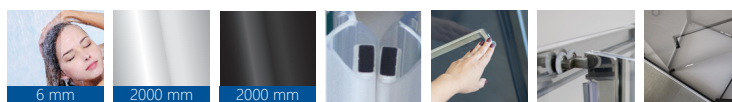



Družine tuš kabin in njihove značilnosti

A range of shower enclosures and their characteristics

Skupine tuš-kabina i njihove karakteristike

Asortiman tuš kabina i njihove karakteristike



Venus UNI

> 173

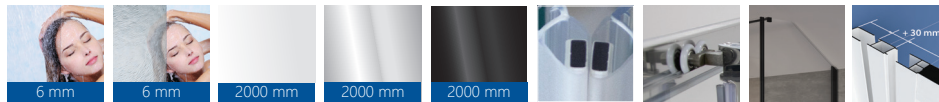

Luna UNI

> 189

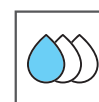

Eco Quat

> 197

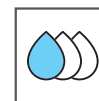

Krilni zasloni za kopalne kadi

Bathtub screens

Zaštitni paravani za kadu

Zaštitni paravani za kade



Polaris UNI

> 201

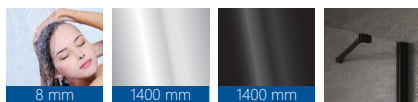

Andromeda UNI

> 205

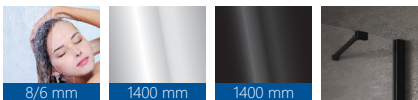

Sole UNI

> 209

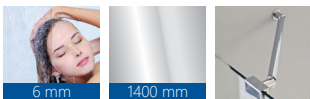

Quat UNI

> 213

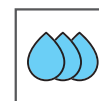
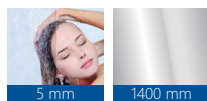













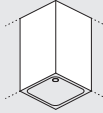
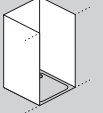
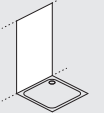
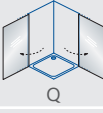
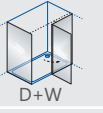

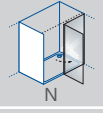
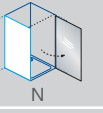
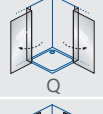

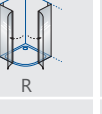
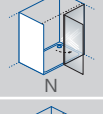
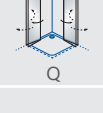
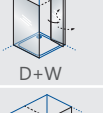
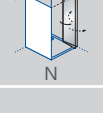

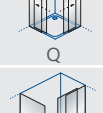

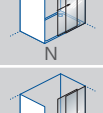
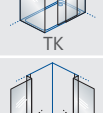
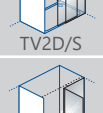

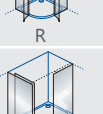

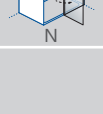
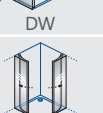
Tuš kabine - preglednica po oblikah in postavitvah

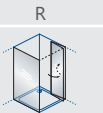
Shower enclosures - shapes and sizes

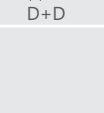
Tuš kabine - pregled po oblicima i dimenzijama

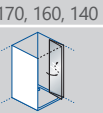
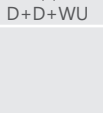
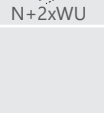
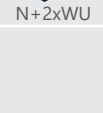
Tuš kabine - tabela po oblicima i načinu postavljanja

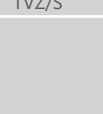
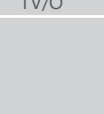
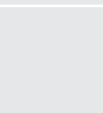
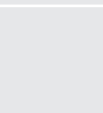

program range program program										
Andromeda UNI	 Q	 D+W	 D+W		 N	 N				
Polaris	 Q	 D+W	 R		 N					
Polaris Fold	 Q	 D+W			 N					
Calypso UNI		 WO								
Libra	 Q	 DW			 N					
Virgo UNI	 TK				 TV2D/S					
Aquarius UNI	 Q	 R	 D+W		 N					
Stellar UNI		 DW								
Venus UNI	 Q	 R	 D+W	 D+D	 N 120, 110, 100	 N 170, 160, 140		 D+D+WU	 N+2xWU	 N+2xWU
Luna UNI	 TV3D/S+TSv3D	 TVZ/S+TSvZ			 TV3D/S	 TVZ/S	 TV/O			
Eco Quat	 TKK	 TKP								
Sole UNI										
Quat UNI										

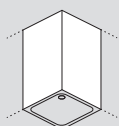

kotna postavitve
corner
kutno postavljanje
ugaono postavljanje

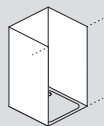

postavitve v niši
recessed
postavljanje u niši
postavljanje u niši

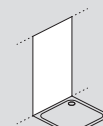

postavitve ob steni
wall
postavljanje uz zid
postavljanje uz zid



program range program program		
Andromeda UNI	 BS 120	 BS 80
Polaris UNI	 BS 80	
Polaris Fold		
Calypso UNI		
Libra		
Virgo UNI		
Aquarius UNI		
Stellar UNI		
Venus UNI		
Luna UNI		
Eco Quat		
Sole UNI	 TP 104 UNI	 TP 102 UNI
Quat UNI		 TP 80 UNI



Info

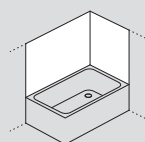

kotna postavitev
corner
kutno postavljanje
ugaono postavljanje



8 mm



2000 mm



6 mm



POLARIS



Družine tuš kabin in njihove značilnosti

A range of shower enclosures and their characteristics

Skupine tuš-kabina i njihove karakteristike

Asortiman tuš kabina i njihove karakteristike



8/6 mm KALJENO PROZORNO STEKLO

8/6 mm transparent tempered glass
8/6 mm kaljeno prozorno staklo
8/6 mm prozorno kaljeno staklo



SBR

2000 mm SILVER BRILL PROFILI (VISOKOPOLIRANA SREBRNA GALVANSKA PREVLEKA)

2000 mm Silver Brill Profiles (high gloss-polished silver galvanised coating)
2000 mm Silver Brill profili (visokopolirana srebrna galvanska prevlaka)
2000 mm Silver Brill profili (visokopolirani srebrni galvanski premaz)

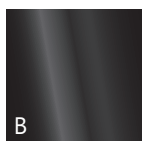

B

2000 mm BLACK (ČRNI) PROFILI, PRAŠNO LAKIRANJE

2000 mm BLACK profiles, powder coating
2000 mm BLACK (crni) profili, lakiranje prahom
2000 mm BLACK (crni) profili, suvo lakiranje



ZAPIRANJE Z MAGNETNIM PROFILOM

magnetic closure
zatvaranje s magnetnim profilom
zatvaranje pomoću gnetnog profila

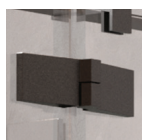

TEČAJI Z DVIŽNO FUNKCIJO

hinges with lifting function
šarke s podiznom funkcijom
šarke sa funkcijom podizanja



OPORA ZA STABILNOST TUŠ KABINE

support for the stability of the shower enclosure
potpora za stabilnost tuš kabine
oslonac za stabilnost tuš kabine



DODATNI ALUMINIJASTI PROFIL NA TUŠ KADI PREPREČUJE IZTEKANJE VODE

an additional shower door threshold prevents overflow
dodatni aluminijasti profil na tuš kadi sprječava istjecanje vode
dodatni aluminijumski profil na tuš kadi sprečava izlivanje vode

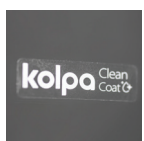

kolpa Clean Coat

CLEAN COAT, ZAŠČITNI PREMAZ

Clean coat, protective coating
Clean coat, zaštitni premaz
Clean coat, zaštitni premaz



TUŠ KABINA PO MERI

Custom shower cabin
Tuš kabina po mjeri
Tuš kabina po mjeri

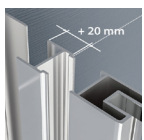

+ 20 mm

MOŽNOST KOMPENZACIJSKEGA PROFILA K 20 – ZA Q, R, N, D IN W

optional compensation Profiles K 20 – for Q, R, D, and W
mogućnost kompenzacijskog profila K 20 – za Q, R, D i W
mogućnost kompenzatornog profila K 20 – za Q, R, D i W

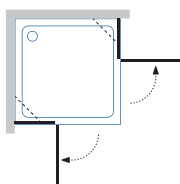

Polaris Q

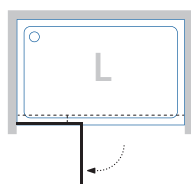

Polaris N -L

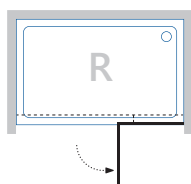

Polaris N -R

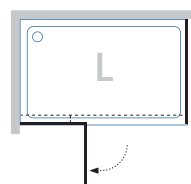

Polaris D+W -L

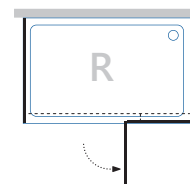

Polaris D+W -R

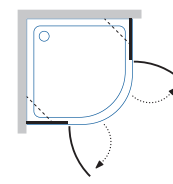

Polaris R

Polaris Q 100, 90, 80

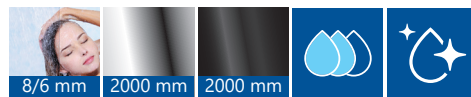

128

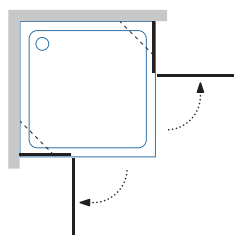

Q 100, 90, 80

- Kotna tuš kabina z dvema vratnima kriloma na tečajih.
- Corner shower enclosure with double-wing doors.
- Kutna tuš kabina s dva vratna krila na šarkama.
- Četvrtasta tuš kabina sa dva vratna krila na šarkama.

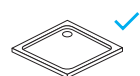
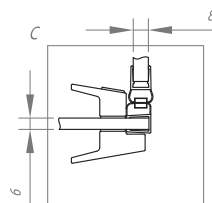
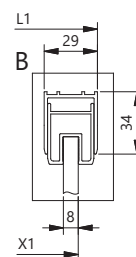
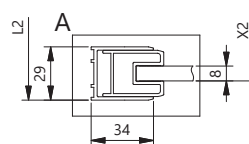
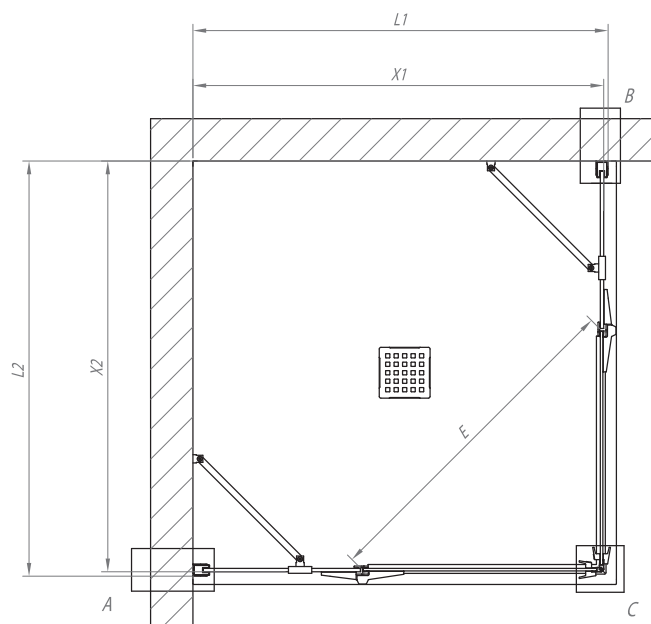

Menora, Menora Zero, Hopp, Tello, Moonwalk, Serra 90x90, Tobas, Capo, Canary, Drop, Flamenco, Evelin Tray Q, Trin.

Polaris			L1	L2	X1	X2		E	
Q 100			980 - 990	980 - 990	970 - 980	970 - 980	2000	790	
Q 90			880 - 890	880 - 890	870 - 880	870 - 880	2000	790	
Q 80			780 - 790	780 - 790	770 - 780	770 - 780	2000	650	

Polaris Q 100, 90, 80

Polaris N 140, 120, 100, 90 - L,R

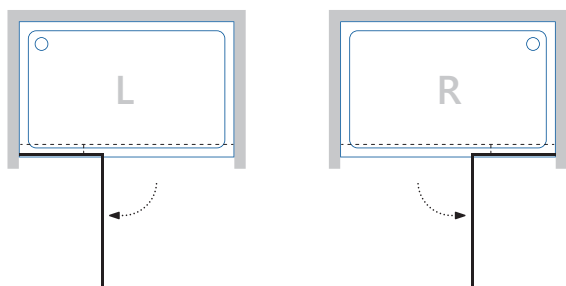
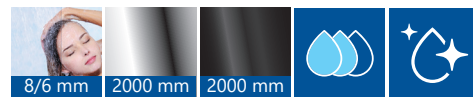

N 140, 120, 100, 90 - L,D

- Samostojna tuš vrata, enostransko odpiranje.
- Self-supporting shower door, single-side opening.
- Samostojeća tuš vrata, jednostrano otvaranje.
- Samostojeća tuš vrata, jednostrano otvaranje.

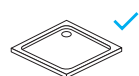
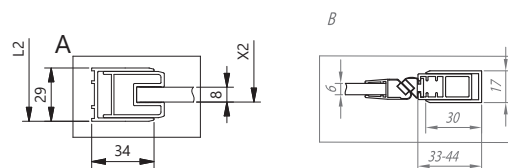
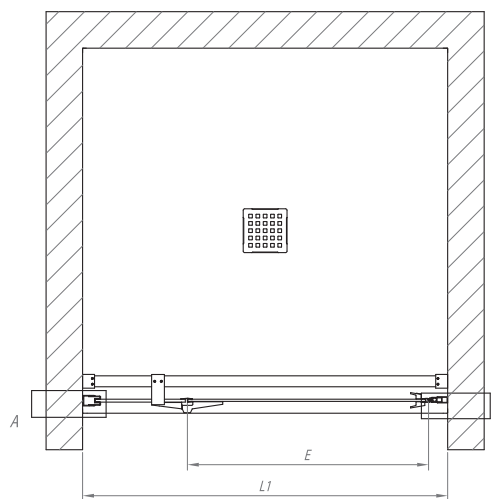

Hopp, Menora, Menora zero, Ballo, Tello, Moonwalk, Re-walk, Canary, Serra, Tobas, Drop, Flamenco, Evelin Tray Q, Trin.

Polaris			L1	L2	X1	X2		E	
N 140			1380 - 1400				2000	630	
N 120			1180 - 1200				2000	630	
N 100			980 - 1000				2000	630	
N 90			880 - 900				2000	530	

Polaris D 140, 120, 100, 90, 80 + W 100, 90, 80

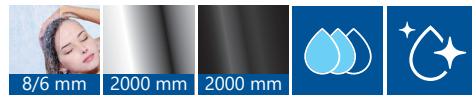

130

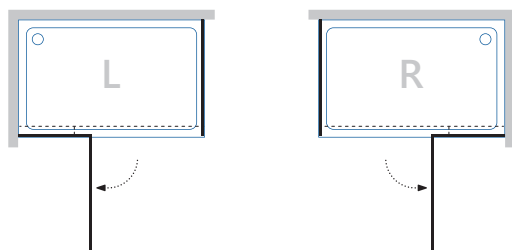

D 140, 120, 100, 90, 80 + W 100, 90, 80

- Tuš vrata s tuš steno.
- Shower door with shower wall.
- Tuš vrata s tuš stijenom.
- Tuš vrata sa tuš stenom.

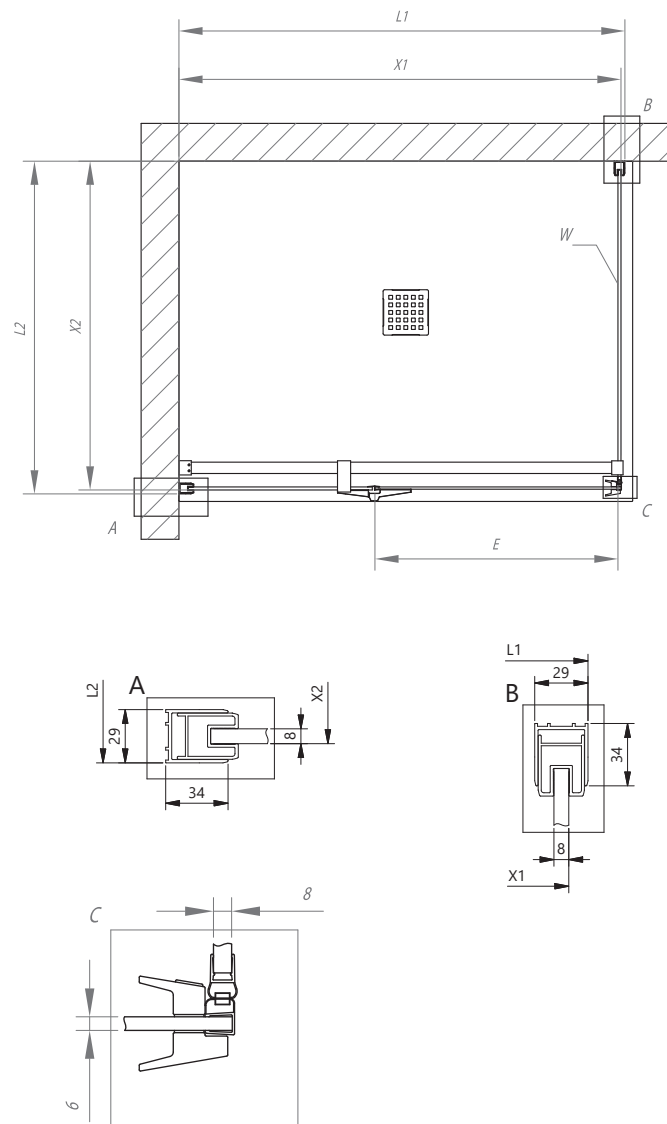

Polaris D 140, 120, 100, 90, 80 + W 100, 90, 80

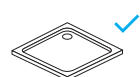

Hopp, Menora, Menora zero, Ballo, Tello, Moonwalk, Re-walk, Serra, Tobas, Canary, Drop, Flamenco, Evelin Tray Q.

Polaris			L1	L2	X1	X2		E	
D 140			1380 - 1390		1370 - 1380		2000	610	
D 120			1180 - 1190		1170 - 1180		2000	610	
D 100			980 - 990		970 - 980		2000	610	
D 90			880 - 890		870 - 880		2000	510	
D 80			780 - 790		770 - 780		2000	450	
W 100				980 - 990		970 - 980	2000		
W 90				880 - 890		870 - 880	2000		
W 80				780 - 790		770 - 780	2000		

Polaris R 100, 90

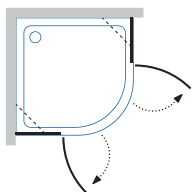
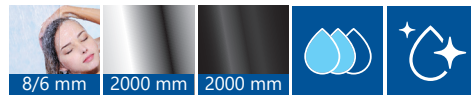

R 100, 90

- Polkrožna tuš kabina z dvema vratnima kriloma na tečajih.
- Semi-circular shower enclosure with double-wing doors.
- Polukružna tuš kabina s dva vratna krila na šarkama.
- Polukružna tuš kabina sa dva vratna krila na šarkama.

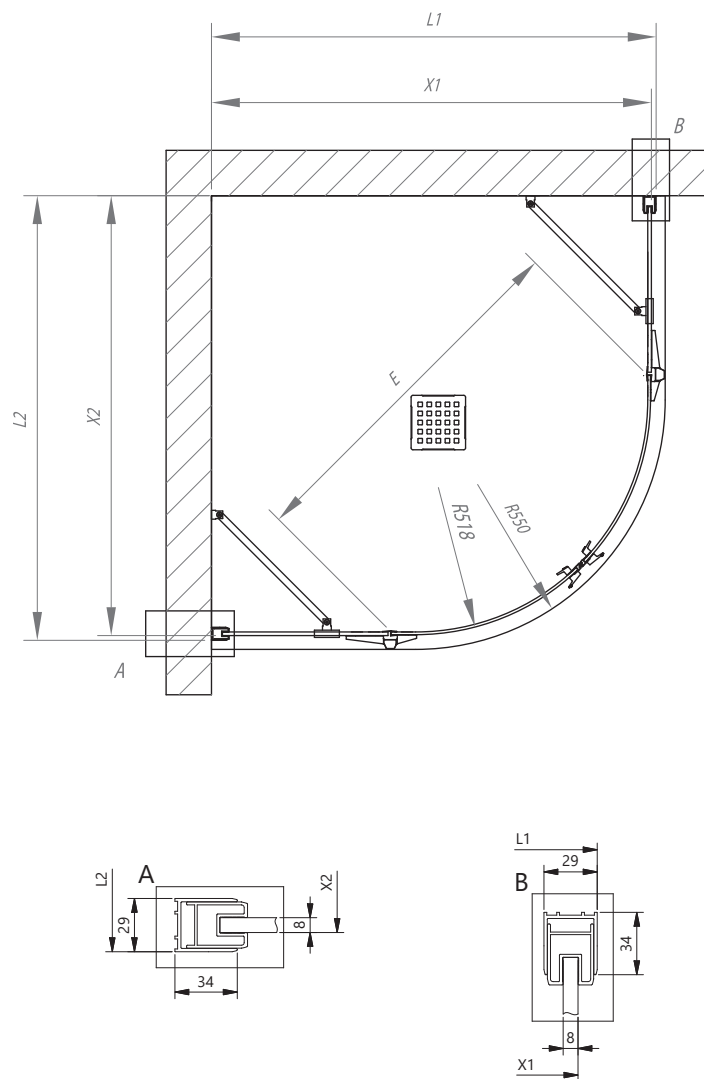

Menora R, Hopp R, Moonwalk R, Macarena, Drop R, Evelin Tray R, Ontex.

Polaris			L1	L2	X1	X2			E	
R 100			980 - 990	980 - 990	970 - 980	970 - 980	550	2000	775	
R 90			880 - 890	880 - 890	870 - 880	870 - 880	550	2000	775	

Dodatni profili

Additional profiles

Dodatni profili

Dodatni profili

Dodatni profil za izvedbo nestandardnih dimenzij kabin po širini.

Različica s kompenzacijskim profilom K 20

– za Q, R, N, D in W

Additional profiles for fitting nonstandard dimension enclosure widths.

The variant with the compensational profile

K 20 – for Q, R, N, D in W

Dodatni profil za podešavanje izvan-standardnih dimenzija kabina po širini.

Varijanta s kompenzacijskim profilom K 20

– za Q, R, N, D i W

Dodatni profil za ugradnju nestandardnih dimenzija kabina po širini.

Varijanta sa kompenzacionim profilom K 20



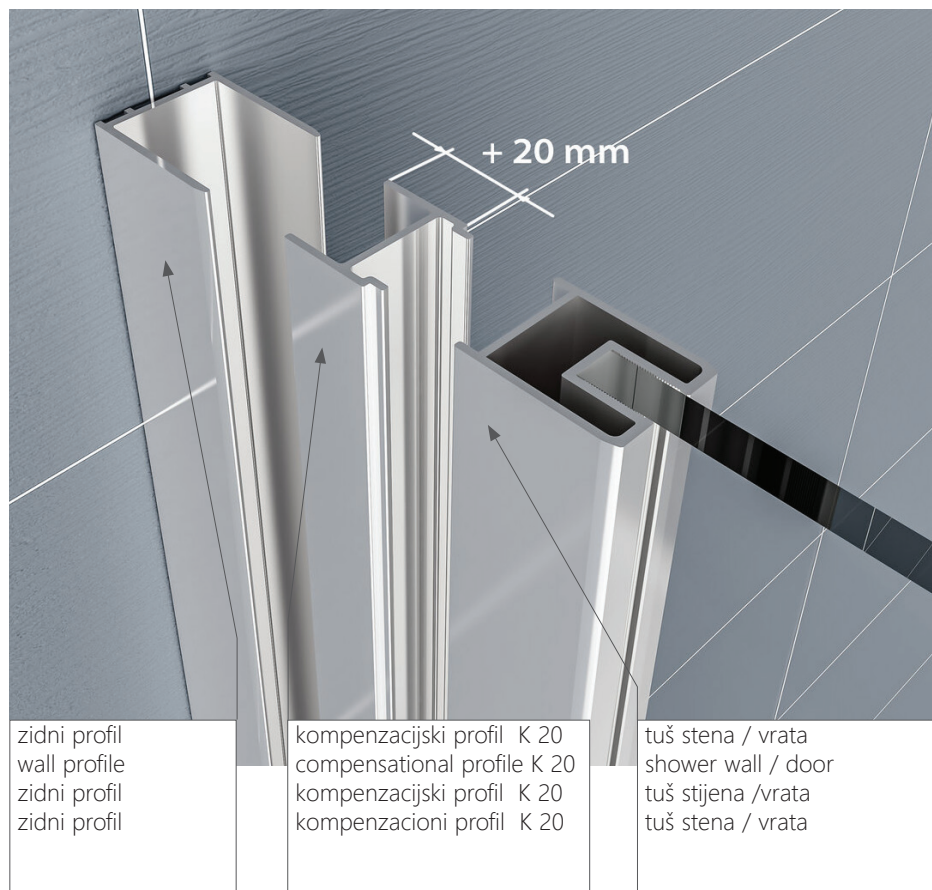

– za Q, R, N, D i W



zidni profil
wall profile
zidni profil
zidni profil

kompenzacijski profil K 20
compensational profile K 20
kompenzacijski profil K 20
kompenzacioni profil K 20

tuš stena / vrata
shower wall / door
tuš stijena /vrata
tuš stena / vrata

Tip/Type		Vrsta profila / Type of profile		
K-20 SBR Profil		dodatni profil za Q, R, N, D in W additional profile Q, R, N, D and W	2000	20
K-20 B Profil		dodatni profil za Q, R, N, D in W additional profile Q, R, N, D and W	2000	20





POLARIS FOLD



Družine tuš kabin in njihove značilnosti

A range of shower enclosures and their characteristics

Skupine tuš-kabina i njihove karakteristike

Assortiman tuš kabina i njihove karakteristike



8/6 mm KALJENO PROZORNO STEKLO

8/6 mm transparent tempered glass

8/6 mm kaljeno prozirno staklo

8/6 mm prozirno kaljeno staklo



SBR

2000 mm SILVER BRILL PROFILI (VISOKOPOLIRANA SREBRNA GALVANSKA PREVLEKA)

2000 mm Silver Brill Profiles (high gloss-polished silver galvanised coating)

2000 mm Silver Brill profili (visokopolirana srebrna galvanska prevlaka)

2000 mm Silver Brill profili (visokopolirani srebrni galvanski premaz)

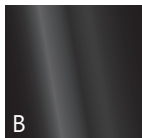

B

2000 mm BLACK (ČRNI) PROFILI, PRAŠNO LAKIRANJE

2000 mm BLACK profiles, powder coating

2000 mm BLACK (crni) profili, lakiranje prahom

2000 mm BLACK (crni) profili, suvo lakiranje



ZAPIRANJE Z MAGNETNIM PROFILOM

magnetic closure

zatvaranje s magnetnim profilom

zatvaranje pomoću magnetnog profila



TEČAJI IN OBRAČALNI PROFIL Z DVIŽNO FUNKCIJO

hinges and a turning profile with a lifting function.

šarke i okretni profil s podiznom funkcijom

šarke i okretni profil sa funkcijom podizanja



OPORA ZA STABILNOST TUŠ KABINE

support for the stability of the shower enclosure

potpora za stabilnost tuš kabine

oslonac za stabilnost tuš kabine



DODATNI ALUMINIJASTI PROFIL NA TUŠ KADI PREPREČUJE IZTEKANJE VODE

an additional shower door threshold prevents overflow

dodatni aluminijски profil na tuš kadi sprječava istjecanje vode

dodatni aluminijumski profil na tuš kadi sprečava izlivanje vode

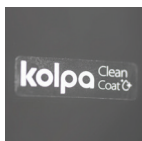

kolpa Clean Coat

CLEAN COAT, ZAŠČITNI PREMAZ

Clean coat, protective coating

Clean coat, zaštitni premaz

Clean coat, zaštitni premaz



TUŠ KABINA PO MERI

Custom shower cabin

Tuš kabina po mjeri

Tuš kabina po mjeri

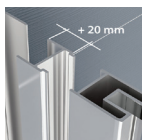

+20 mm

MOŽNOST KOMPENZACIJSKEGA PROFILA K 20 – ZA W 100, 90, 80

optional compensation Profiles K 20 – for W 100, 90, 80

mogućnost kompenzacijskog profila K 20 – W 100, 90, 80

mogućnost kompenzatornog profila K 20 – za W 100, 90, 80

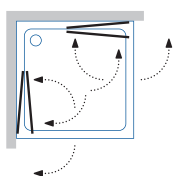

Polaris Fold Q

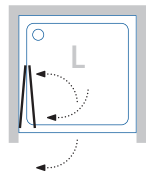

Polaris Fold N -L

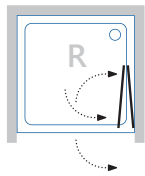

Polaris Fold N -R

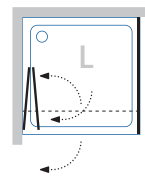

Polaris Fold D+W -L

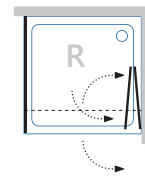

Polaris Fold D+W -R

Polaris fold Q 100, 90, 80

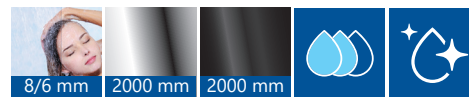

136

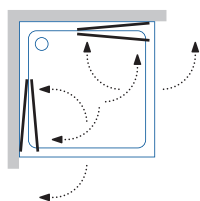

Q 100, 90, 80

- Kotna tuš kabina, zložljiva na notranjo ali zunanjo stran.
- Corner shower cabin, can fold inwards or outwards.
- Kutna tuš kabina, sklopiva na unutarnju i vanjsku stranu.
- Ugaona tuš kabina, sklopiva na unutrašnju ili spoljašnju stranu.

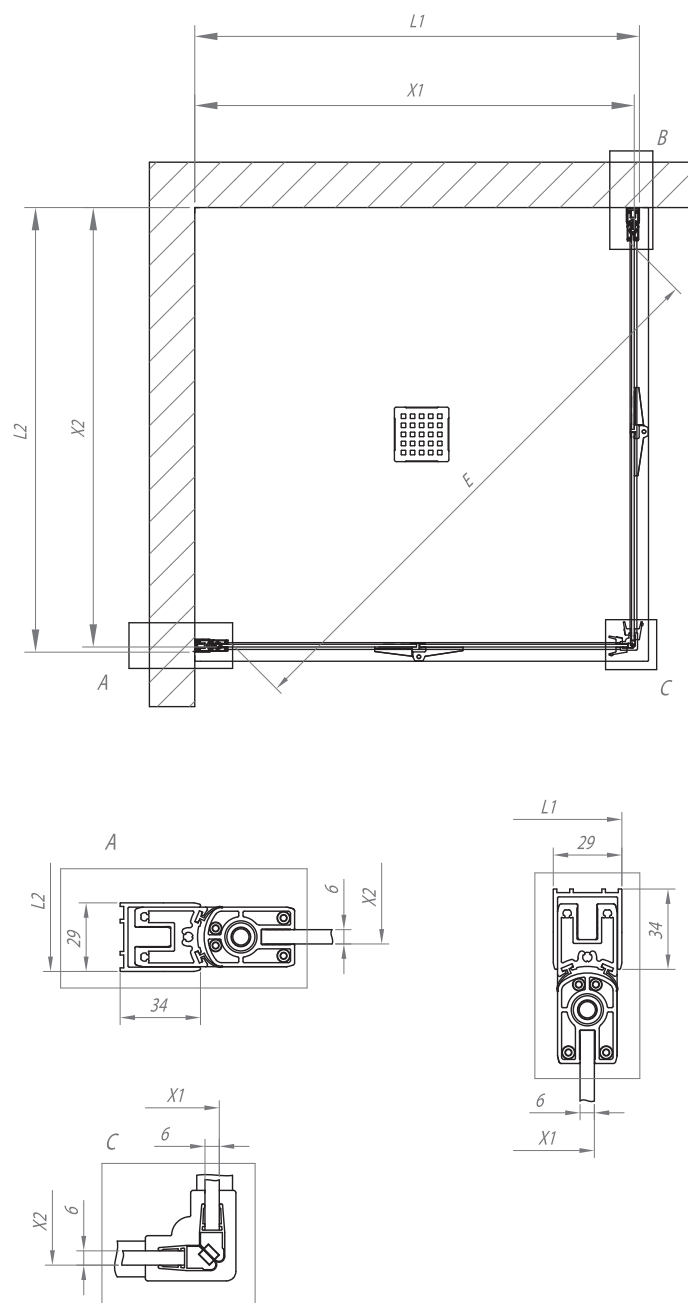

Polaris fold Q 100, 90, 80

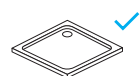

Hopp, Menora, Menora zero, Ballo, Tello, Moonwalk, Re-walk, Capo, Canary, Serra, Tobas, Drop, Flamenco, Evelin Tray Q.

Polaris fold			L1	L2	X1	X2		E	
Q 100			980 - 990	980 - 990	969 - 979	969 - 979	2000	1250	
Q 90			880 - 890	880 - 890	869 - 879	869 - 879	2000	1100	
Q 80			780 - 790	780 - 790	769 - 779	769 - 779	2000	970	

Polaris fold N 100, 90, 80

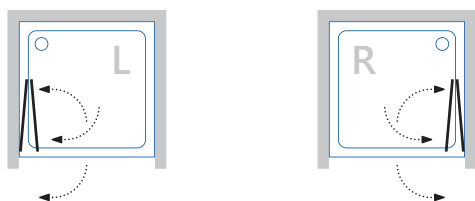
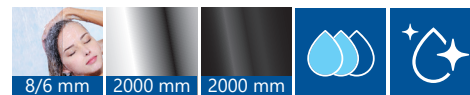

N 100, 90, 80

- Samostojna tuš vrata, zložljiva na notranjo ali zunanjo stran. Možnost montaže v nišo.
- Self-supporting shower door, single-side opening. Installed in a niche.
- Samostoječa tuš vrata, sklopiva na unutarjnu i vanjsku stranu. Mogućnost montaže u nišu.
- Samostoječa tuš vrata, sklopiva na unutrašnju ili spoljašnju stranu. Mogućnost montaže u nišu.

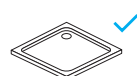
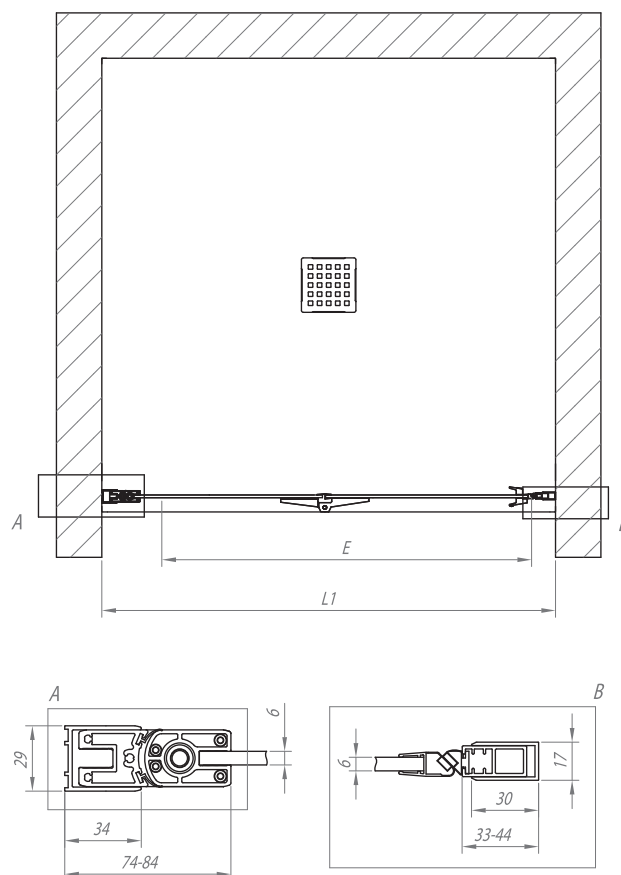

✓ Hopp, Menora, Menora zero, Ballo, Tello, Moonwalk, Re-walk, Capo, Canary, Serra, Tobas, Drop, Flamenco, Evelin Tray Q.

Polaris fold			L1	L2	X1	X2		E	
N 100			980 - 1000				2000	815	
N 90			880 - 900				2000	715	
N 80			780 - 800				2000	615	

Polaris fold D 100, 90, 80 + W 100, 90, 80

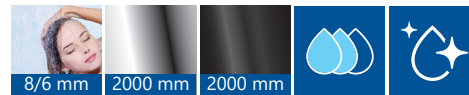

138



D 100, 90, 80 + W 100, 90, 80

- Tuš kabina - vrata in stena, zložljiva na notranjo ali zunanjo stran.
- Shower enclosure - door and wall, can fold inwards or outwards.
- Tuš kabina - vrata i stijena, sklopiva na unutrašnju i vanjsku stranu.
- Tuš kabina - vrata i stena, sklopiva na unutrašnju ili spoljašnju stranu.

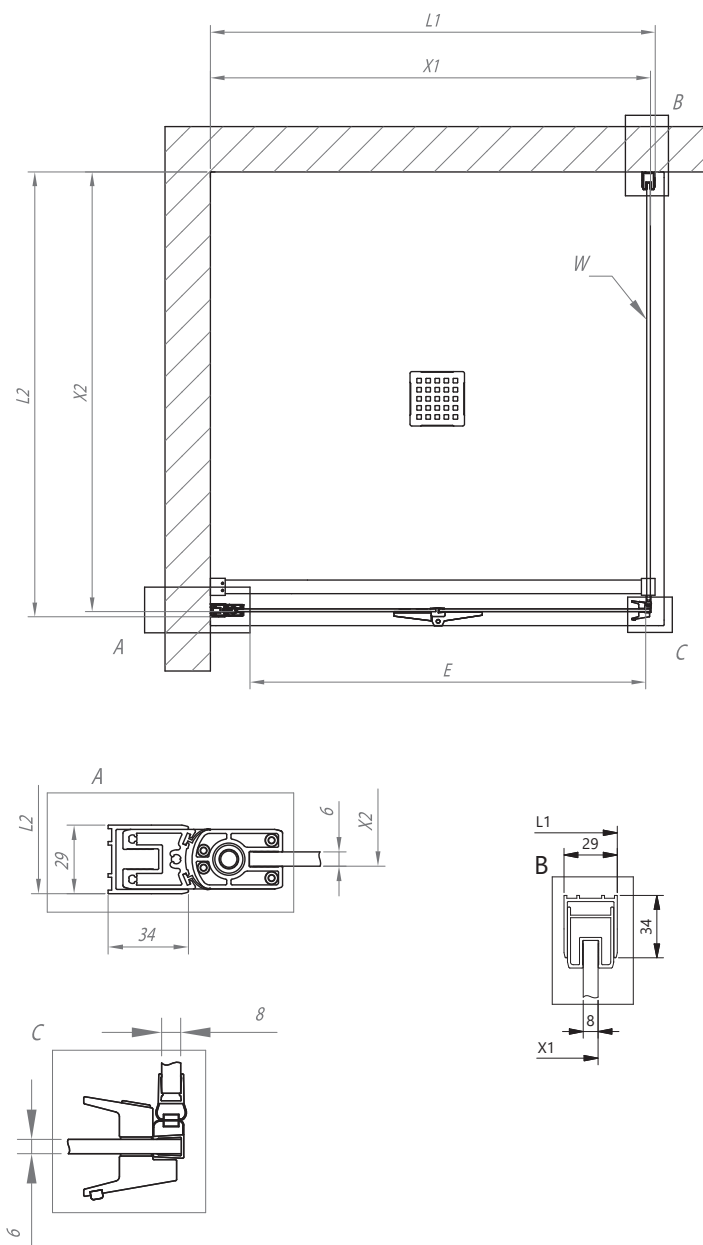

Polaris fold D 100, 90, 80 + W 100, 90, 80

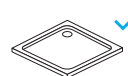

Menora, Menora Zero, Hopp, Tello, Moonwalk, Re-walk, Capo, Canary, Serra, Tobas, Drop, Flamenco, Evelin Tray Q.

Polaris fold			L1	L2	X1	X2		E	
W 100			980 - 990	980 - 990		969 - 979	2000		
W 90			880 - 890	880 - 890		869 - 879	2000		
W 80			780 - 790	780 - 790		769 - 779	2000		
D 100			980 - 990		970 - 980		2000	840	
D 90			880 - 890		870 - 880		2000	740	
D 80			780 - 790		770 - 780		2000	640	

Dodatni profili

Additional profiles

Dodatni profili

Dodatni profili



Dodatni profil za izvedbo nestandardnih dimenzij kabin po širini.

Različica s kompenzacijskim profilom K 20
– samo za POLARIS FOLD W 100, 90, 80

Additional profiles for fitting nonstandard dimension enclosure widths.

The variant with the compensational profile K 20 – only for POLARIS FOLD W 100, 90, 80

Dodatni profil za podešavanje izvan-standardnih dimenzija kabina po širini.

Varijanta s kompenzacijskim profilom K 20
– samo za POLARIS FOLD W 100, 90, 80

Dodatni profil za ugradnju nestandardnih dimenzija kabina po širini.

Varijanta sa kompenzacionim profilom K 20
– samo za POLARIS FOLD W 100, 90, 80

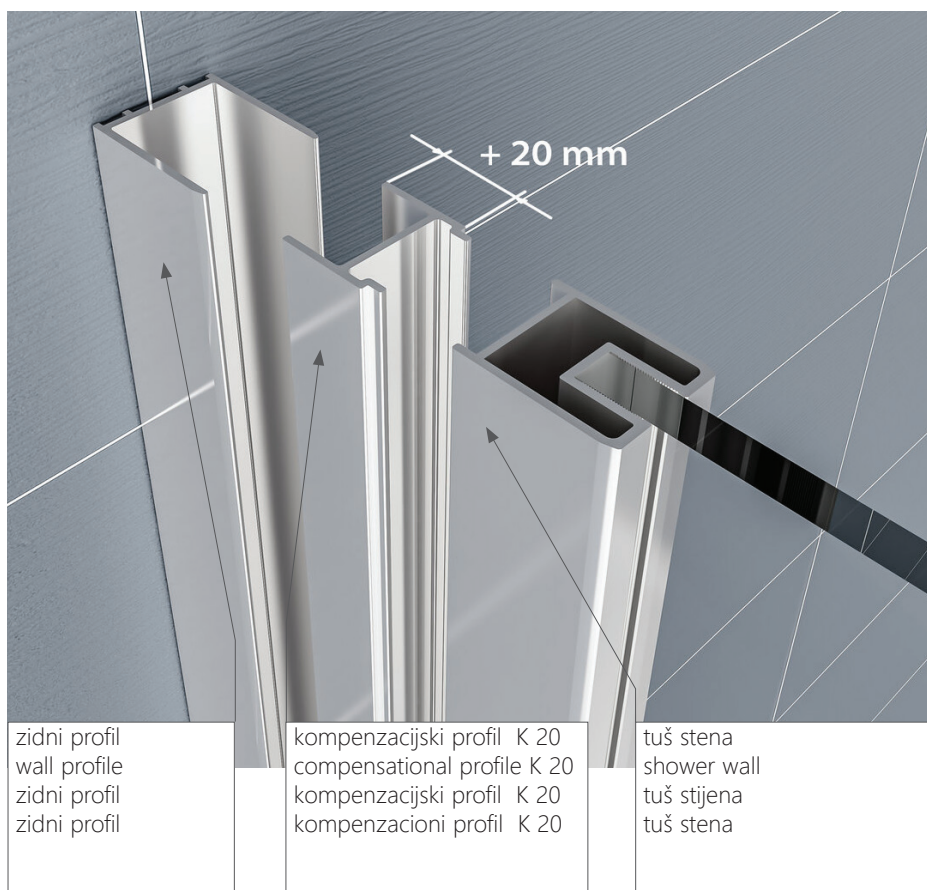

zidni profil
wall profile
zidni profil
zidni profil

kompenzacijski profil K 20
compensational profile K 20
kompenzacijski profil K 20
kompenzacioni profil K 20

tuš stena
shower wall
tuš stijena
tuš stena

Tip /Type	Vrsta profila / Type of profile		
K-20 SBR Profil	dodatni profil samo za POLARIS FOLD W 100, 90, 80 additional profile only for POLARIS FOLD W 100, 90, 80	2000	20
K-20 B Profil	dodatni profil samo za POLARIS FOLD W 100, 90, 80 additional profile only for POLARIS FOLD W 100, 90, 80	2000	20



8 mm



2000 mm



6 mm



ANDROMEDA UNI



Družine tuš kabin in njihove značilnosti

A range of shower enclosures and their characteristics

Skupine tuš-kabina i njihove karakteristike

Assortiman tuš kabina i njihove karakteristike



8/6 MM KALJENO PROZORNO STEKLO

8/6 mm transparent tempered glass
8/6 mm kaljeno prozorno staklo
8/6 mm prozorno kaljeno staklo



SBR

2000 mm SILVER BRILL PROFILI (VISOKOPOLIRANA SREBRNA GALVANSKA PREVLEKA)

2000 mm Silver Brill Profiles (high gloss-polished silver galvanised coating)
2000 mm Silver Brill profili (visokopolirana srebrna galvanska prevlaka)
2000 mm Silver Brill profili (visokopolirani srebrni galvanski premaz)

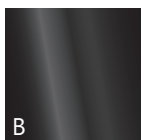

B

2000 mm BLACK (ČRNI) PROFILI, PRAŠNO LAKIRANJE

2000 mm BLACK profiles, powder coating
2000 mm BLACK (crni) profili, lakiranje prahom
2000 mm BLACK (crni) profili, suvo lakiranje



ZAPIRANJE Z MAGNETNIM PROFILOM

magnetic closure
zatvaranje s magnetnim profilom
zatvaranje pomoću magnetnog profila



OBRAČALNI PROFIL Z DVIŽNO FUNKCIJO

turning section with lifting function
okretni profil s podiznom funkcijom
okretni profil sa funkcijom podizanja



OPORA ZA STABILNOST TUŠ KABINE

support for the stability of the shower enclosure
potpora za stabilnost tuš kabine
oslonac za stabilnost tuš kabine



DODATNI ALUMINIJASTI PROFIL NA TUŠ KADI PREPREČUJE IZTEKANJE VODE

an additional shower door threshold prevents overflow
dodatni aluminijasti profil na tuš kadi sprečava istjecanje vode
dodatni aluminijumski profil na tuš kadi sprečava izlivanje vode

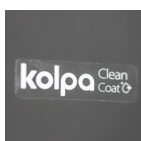

kolpa Clean Coat

CLEAN COAT, ZAŠČITNI PREMAZ

Clean coat, protective coating
Clean coat, zaštitni premaz
Clean coat, zaštitni premaz



TUŠ KABINA PO MERI

Custom shower cabin
Tuš kabina po mjeri
Tuš kabina po meri

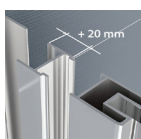

MOŽNOST KOMPENZACIJSKEGA PROFILA K 20 – ZA D (160, 140, 120), N (160, 140, 120) IN W (100, 90, 80)

optional compensation Profiles K 20 – for D (160, 140, 120), N (160, 140, 120) and W (100, 90, 80)
mogućnost kompenzacijskog profila K 20 – za D (160, 140, 120), N (160, 140, 120) i W (100, 90, 80)
mogućnost kompenzatornog profila K 20 – za D (160, 140, 120), N (160, 140, 120) i W (100, 90, 80)

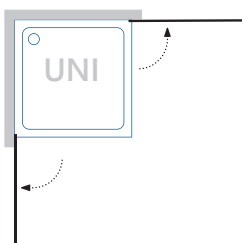

Andromeda UNI Q

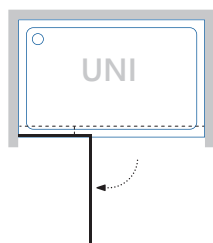
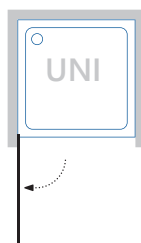
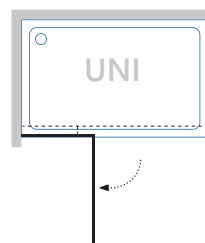
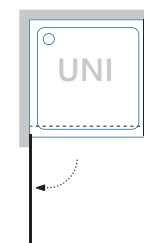
Andromeda UNI
N 160, 140, 120Andromeda UNI
N 100, 90, 80Andromeda UNI
D 160, 140, 120 + W 100, 90, 80Andromeda UNI
D 100, 90, 80 + W 100, 90, 80

Andromeda UNI Q 100, 90, 80

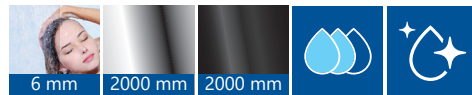

142

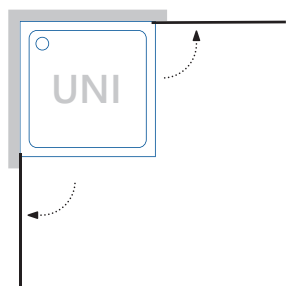

Q 100, 90, 80

- Kotna tuš kabina z dvema vratnima kriloma.
- Corner shower enclosure with double-wing doors.
- Kutna tuš kabina s dva vratna krila.
- Četvrtasta tuš kabina sa dva vratna krila.

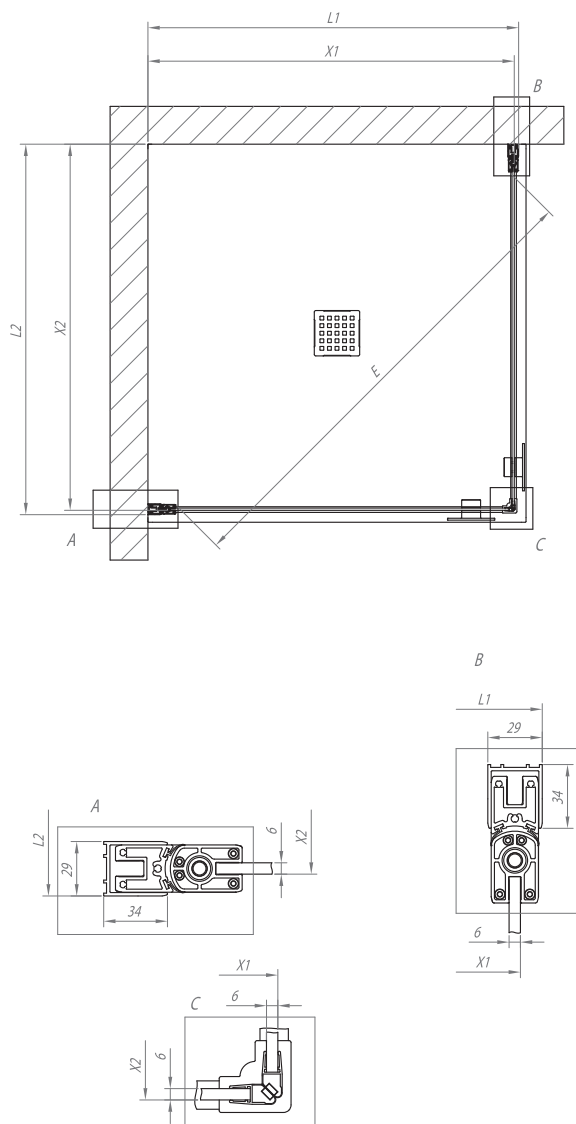

Andromeda UNI Q 100, 90, 80

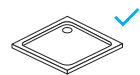

Menora Zero, Menora, Hopp
Tello, Capo, Canary, Drop, Serra,
Tobas, Flamenco, Evelin Tray Q, Trin

Andromeda UNI			L1	L2	X1	X2		E	
Q 100			980 - 990	980 - 990	969 - 979	969 - 979	2000	1250	
Q 90			880 - 890	880 - 890	869 - 879	869 - 879	2000	1100	
Q 80			780 - 790	780 - 790	769 - 779	769 - 779	2000	970	

Andromeda UNI N 160, 140, 120

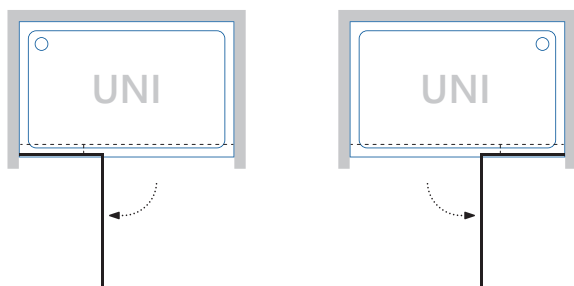
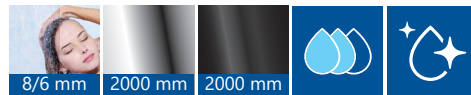

N 160, 140, 120

- Samostojna tuš vrata, enostransko odpiranje.
- Self-supporting shower door, single-side opening.
- Samostalna tuš vrata, jednostrano otvaranje.
- Samostojeća tuš vrata, jednostrano otvaranje.

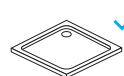
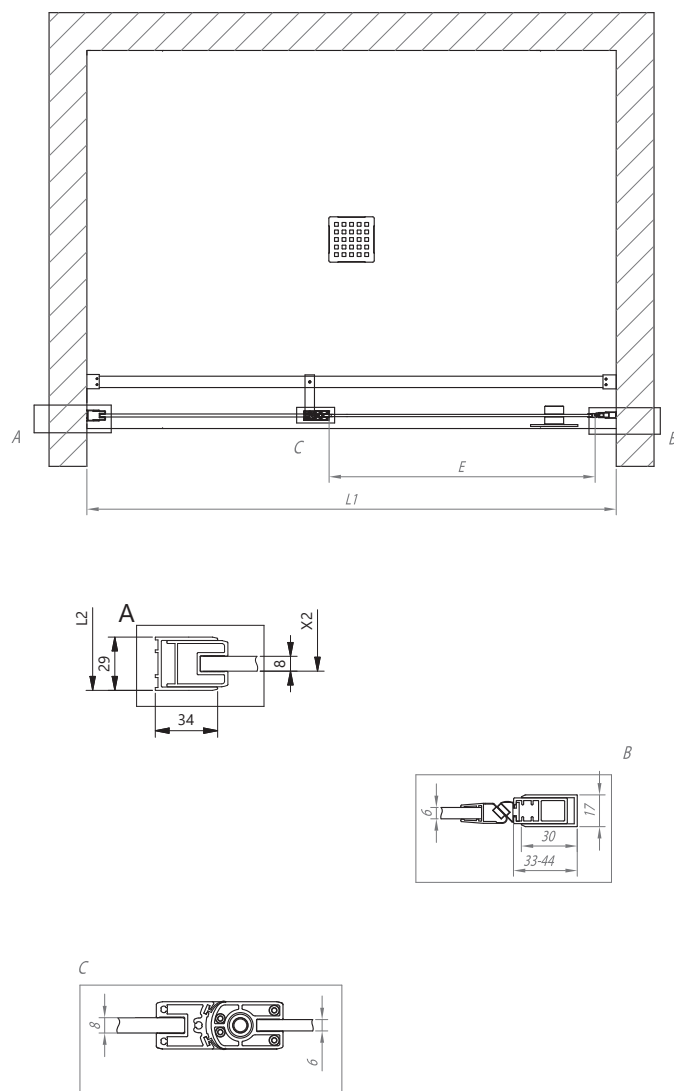

✓ Hopp, Menora, Menora zero, Ballo, Tello, Moonwalk, Re-walk, Capo, Canary, Serra, Tobas, Drop, Flamenco, Evelin Tray Q.

Andromeda UNI			L1	L2	X1	X2		E	
N 160			1580 - 1600				2000	713	
N 140			1380 - 1400				2000	713	
N 120			1180 - 1200				2000	713	

Andromeda UNI N 100, 90, 80

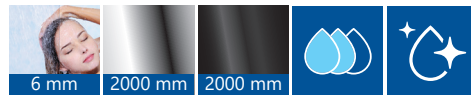

144

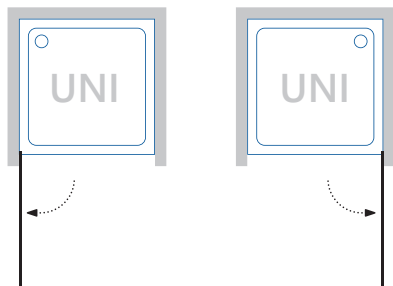

N 100, 90, 80

- Samostojna tuš vrata, enostransko odpiranje.
- Self-supporting shower door, single-side opening.
- Samostalna tuš vrata, jednostrano otvaranje.
- Samostojeća tuš vrata, jednostrano otvaranje.

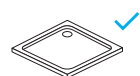
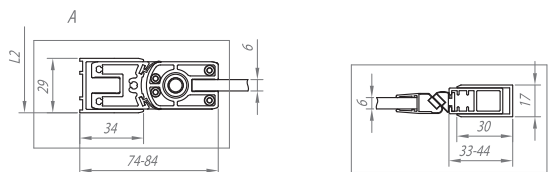
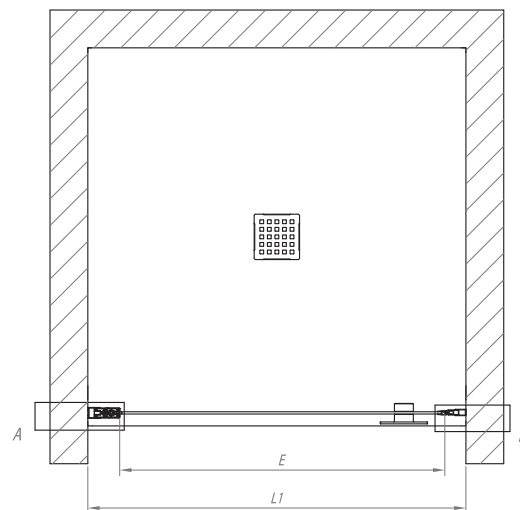

Hopp, Menora, Menora zero, Ballo, Tello, Moonwalk, Re-walk, Capo, Canary, Serra, Tobas, Drop, Flamenco, Evelin Tray Q.

Andromeda UNI			L1	L2	X1	X2		E	
N 100			980 - 1000				2000	870	
N 90			880 - 900				2000	770	
N 80			780 - 800				2000	670	

Andromeda UNI D 160, 140, 120 + W 100, 90, 80

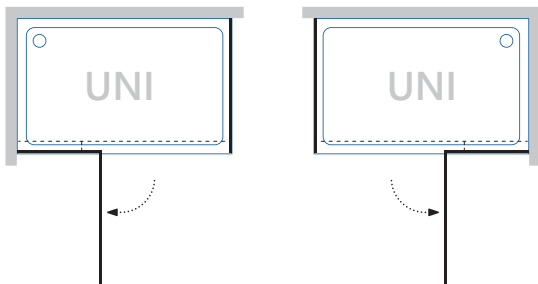
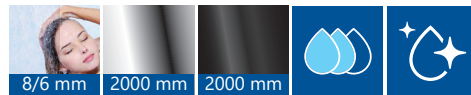

D 160, 140, 120 + W 100, 90, 80

- Tuš vrata s tuš steno.
- Shower door with shower wall.
- Tuš vrata s tuš stijenom.
- Tuš vrata sa tuš stenom.

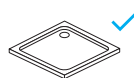
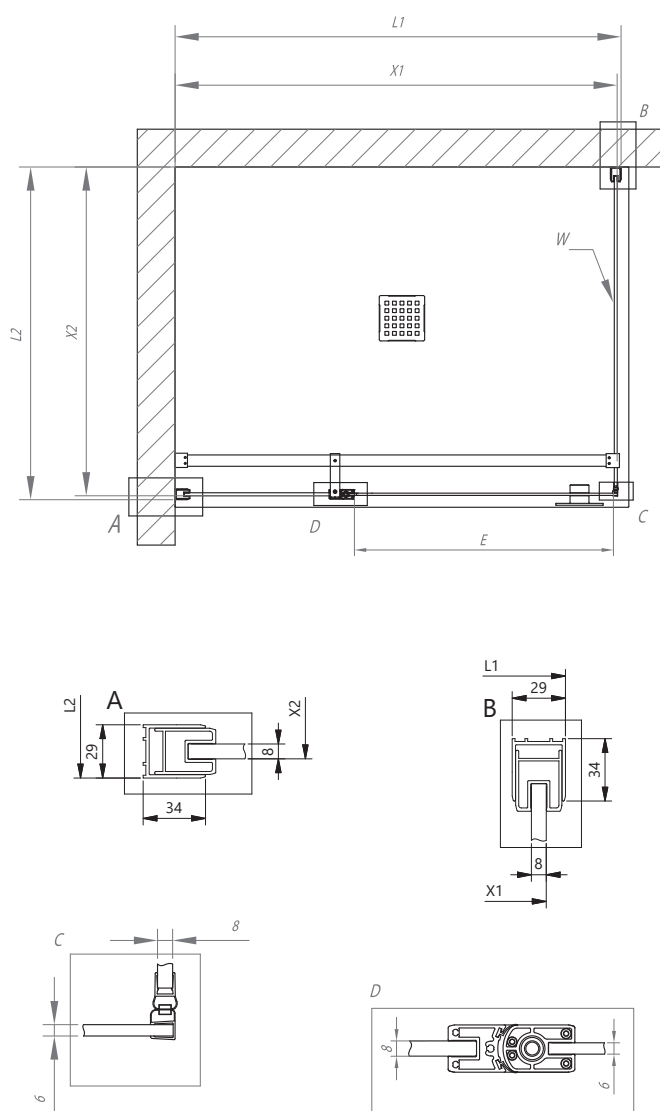

Hopp, Menora, Menora zero, Ballo, Tello, Moonwalk, Re-walk, Serra, Tobas, Canary, Drop, Flamenco, Evelin Tray Q.

Andromeda UNI			L1	L2	X1	X2		E	
D 160			1580 - 1590		1570 - 1580		2000	695	
D 140			1380 - 1390		1370 - 1380		2000	695	
D 120			1180 - 1190		1170 - 1180		2000	695	
W 100				980 - 990		970 - 980	2000		
W 90				880 - 890		870 - 880	2000		
W 80				780 - 790		770 - 780	2000		

Andromeda UNI D 100, 90, 80 + W 100, 90, 80

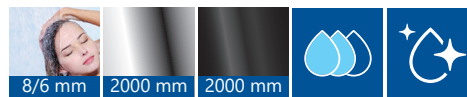

146

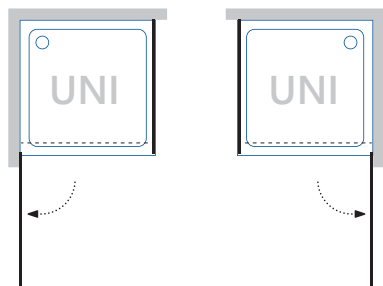

D 100, 90, 80 + W 100, 90, 80

- Tuš vrata s tuš steno.
- Shower door with shower wall.
- Tuš vrata s tuš panelom.
- Tuš vrata sa tuš stenom.

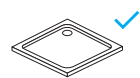
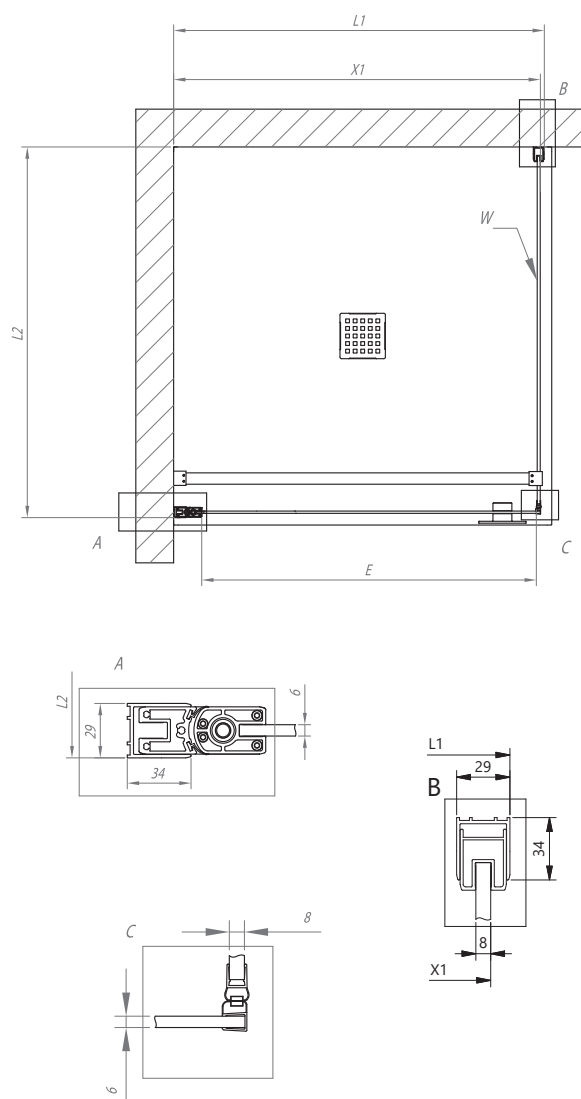

Hopp, Menora, Menora zero, Ballo, Tello, Moonwalk, Re-walk, Serra, Tobas, Canary, Drop, Flamenco, Evelin Tray Q.

Andromeda UNI			L1	L2	X1	X2		E	
D 100			980 - 990		970 - 980		2000	895	
D 90			880 - 890		870 - 880		2000	795	
D 80			780 - 790		770 - 780		2000	695	
W 100				980 - 990		970 - 980	2000		
W 90				880 - 890		870 - 880	2000		
W 80				780 - 790		770 - 780	2000		

Andromeda UNI D 100, 90, 80 + W 100, 90, 80

Dodatni profili

Additional profiles

Dodatni profili

Dodatni profili



Dodatni profil za izvedbo nestandardnih dimenzij kabin po širini.

Različica s kompenzacijskim profilom K 20

– samo za ANDROMEDA D (160, 140, 120), N (160, 140, 120) in W (100, 90, 80)

Additional profiles for fitting nonstandard dimension enclosure widths.

The variant with the compensational profile

K 20 – only for ANDROMEDA D (160, 140, 120), N (160, 140, 120) and W (100, 90, 80)

Dodatni profil za podešavanje izvan-standardnih dimenzija kabina po širini.

Varijanta s kompenzacijskim profilom K 20

– samo za ANDROMEDA D (160, 140, 120), N (160, 140, 120) i W (100, 90, 80)

Dodatni profil za ugradnju nestandardnih dimenzija kabina po širini.

Varijanta sa kompenzacionim profilom K 20

– samo za ANDROMEDA D (160, 140, 120), N (160, 140, 120) i W (100, 90, 80)

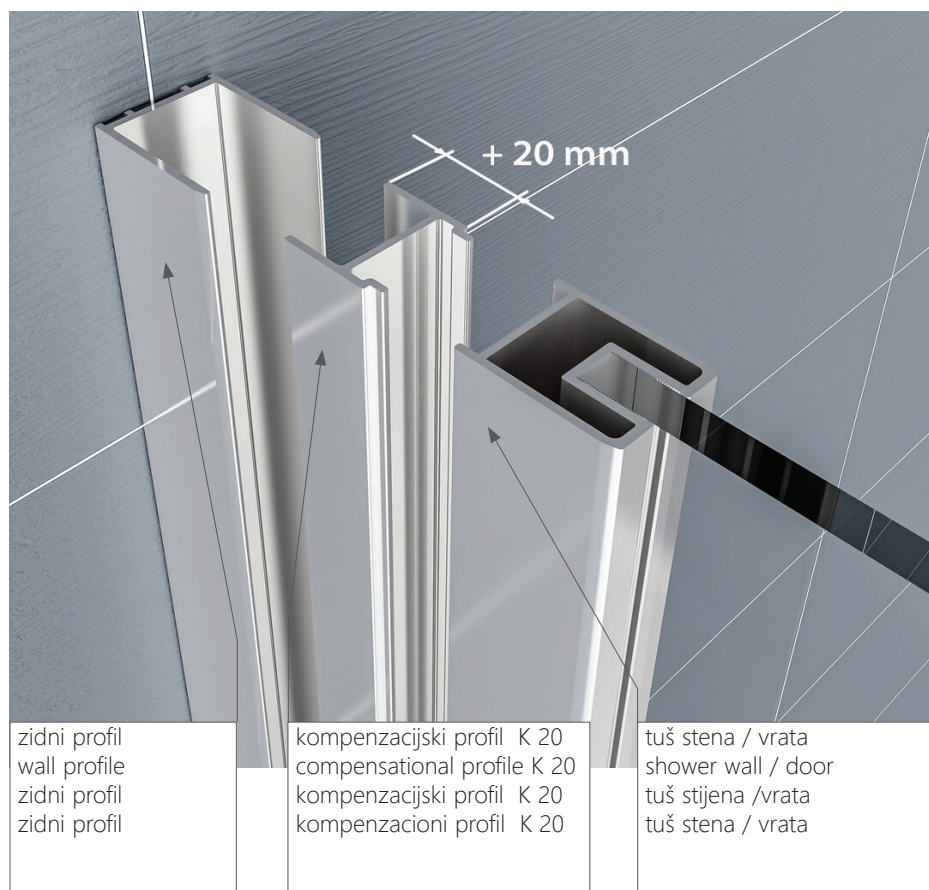

zidni profil
wall profile
zidni profil
zidni profil

kompenzacijski profil K 20
kompenzacijski profil K 20
kompenzacioni profil K 20

tuš stena / vrata
shower wall / door
tuš stijena / vrata
tuš stena / vrata

Tip /Type	Vrsta profila / Type of profile		
K-20 SBR Profil	dodatni profil samo za ANDROMEDA D (160, 140, 120), N (160, 140, 120) in W (100, 90, 80) additional profile only for ANDROMEDA D (160, 140, 120), N (160, 140, 120) and W (100, 90, 80)	2000	20
K-20 B Profil	dodatni profil samo za ANDROMEDA D (160, 140, 120), N (160, 140, 120) in W (100, 90, 80) additional profile only for ANDROMEDA D (160, 140, 120), N (160, 140, 120) and W (100, 90, 80)	2000	20



6 mm

2000 mm

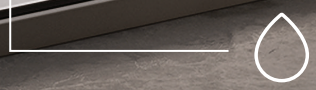

AQUARIUS UNI





Družine tuš kabin in njihove značilnosti

A range of shower enclosures and their characteristics

Skupine tuš-kabina i njihove karakteristike

Assortiman tuš kabina i njihove karakteristike

149



6 mm KALJENO PROZORNO STEKLO

6 mm transparent tempered glass

6 mm kaljeno prozorno staklo

6 mm prozorno kaljeno staklo



SBR

2000 mm SILVER BRILL PROFILI (VISOKOPOLIRANA SREBRNA GALVANSKA PREVLEKA)

2000 mm Silver Brill Profiles (high gloss-polished silver galvanised coating)

2000 mm Silver Brill profili (visokopolirana srebrna galvanska prevlaka)

2000 mm Silver Brill profili (visokopolirani srebrni galvanski premaz)

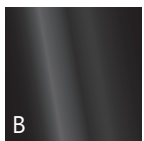

B

2000 mm BLACK (ČRNI) PROFILI, PRAŠNO LAKIRANJE

2000 mm BLACK profiles, powder coating

2000 mm BLACK (crni) profili, lakiranje prahom

2000 mm BLACK (crni) profili, suvo lakiranje



ZAPIRANJE Z MAGNETNIM PROFILOM

magnetic closure

zatvaranje s magnetnim profilom

zatvaranje pomoću magnetnog profila



OPORA ZA STABILNOST TUŠ KABINE

support for the stability of the shower enclosure

potpora za stabilnost tuš kabine

oslonac za stabilnost tuš kabine



DODATNI ALUMINIJASTI PROFIL NA TUŠ KADI PREPREČUJE IZTEKANJE VODE

an additional shower door threshold prevents overflow

dodatni aluminijasti profil na tuš kadi sprječava istjecanje vode

dodatni aluminijumski profil na tuš kadi sprečava izlivanje vode

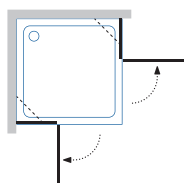

Aquarius UNI Q

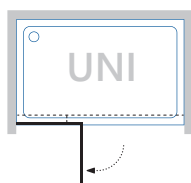

Aquarius UNI N

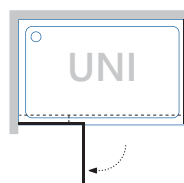

Aquarius UNI D+W

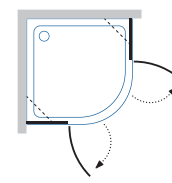

Aquarius UNI R

Aquarius UNI Q 90

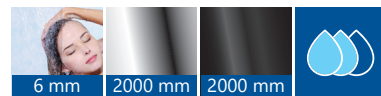

150

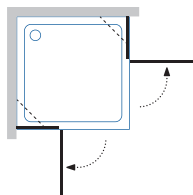

Q 90

- Kotna tuš kabina z dvema vratnima kriloma na tečajih
- Corner shower enclosure with double-wing doors
- Kutna tuš kabina s dva vratna krila na šarkama
- Četrtasta tuš kabina sa dva vratna krila na šarkama

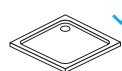
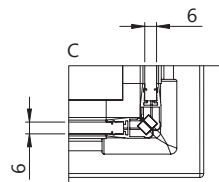
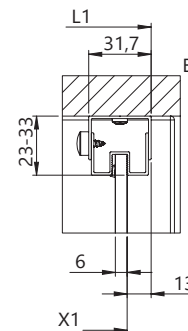
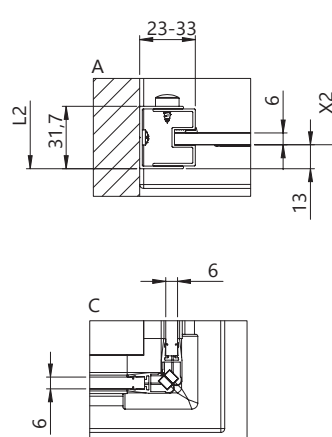
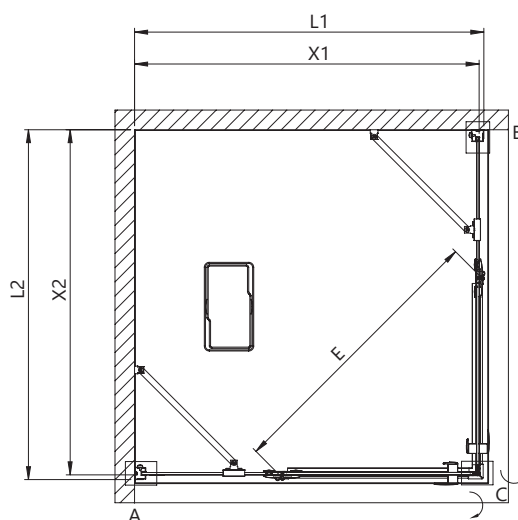

Hopp, Menora, Menora zero, Tello, Moonwalk, Tobas, Capo, Canary, Drop, Serra, Flamenco, Evelin Tray Q, Trin.

Aquarius UNI			L1	L2	X1	X2		E	
Q 90			880 - 890	880 - 890	867 - 877	867 - 877	2000	685	

Aquarius UNI Q 90

Aquarius UNI R 90

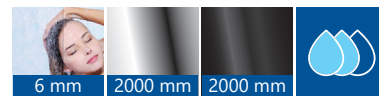

151

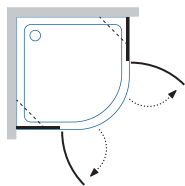

R 90

- Polkrožna tuš kabina, z dvema vratnima kriloma na tečajjih
- Semi-circular shower enclosure, with double-wing doors
- Polukružna tuš kabina, s dva vratna krila na šarkama
- Polukružna tuš kabina, sa dva vratna krila na šarkama

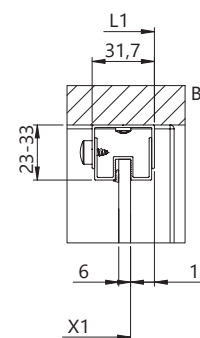
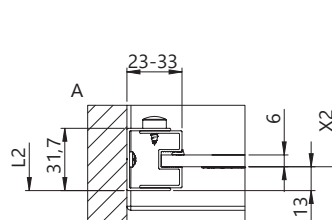
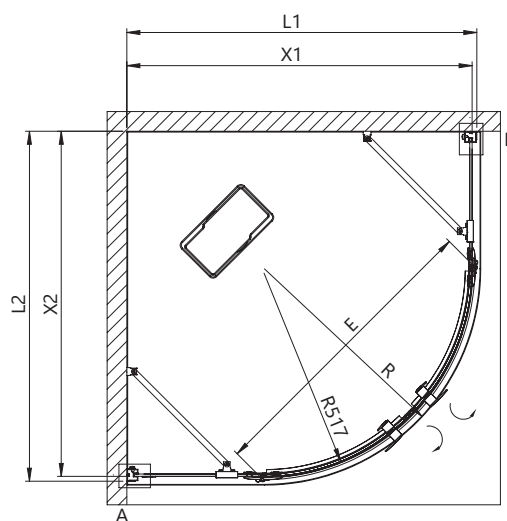

Hopp R, Menora R, Moonwalk R, Macarena, Drop R, Evelin Tray R, Ontex

Aquarius UNI R 90

Aquarius UNI

R 90



L1

880 - 890

L2

880 - 890

X1

867 - 877

X2

867 - 877

2000

E 720



Aquarius UNI D 120, 100, 90 + W 90, 80

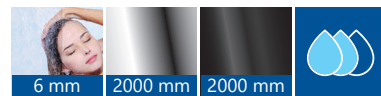

152

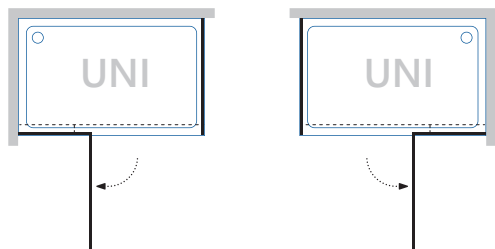

D 120, 100, 90 + W 90, 80

- Kotna tuš kabina z dvema vratnima kriloma na tečajih
- Corner shower enclosure with double-wing doors
- Kutna tuš kabina s vratnim krilom na šarkama i tuš stijenom
- Tuš vrata sa tuš stenom

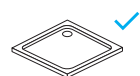
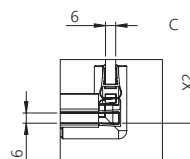
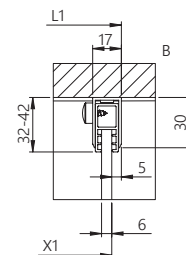
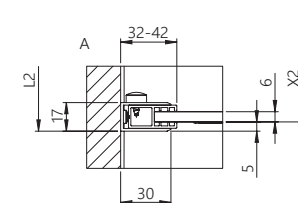
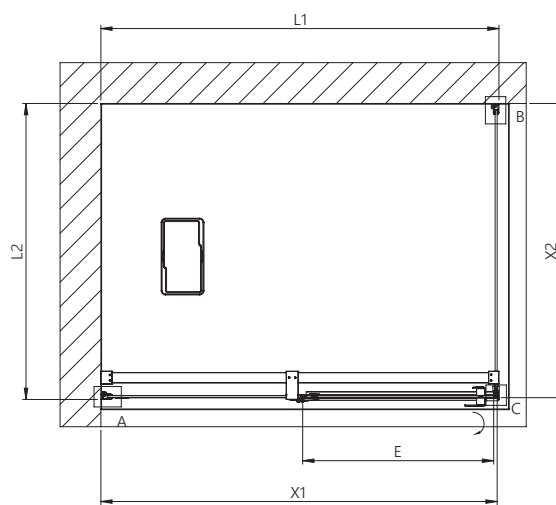

Hopp, Menora, Menora zero, Tello, Moonwalk, Tobas, Capo, Canary, Drop, Serra, Flamenco, Evelin Tray Q, Trin.

Aquarius UNI			L1	L2	X1	X2		E	
D 120			1170 - 1180		1165 - 1175		2000	540	
D 100			970 - 980		965 - 975		2000	510	
D 90			870 - 880		865 - 875		2000	510	
W 90				870 - 880		865 - 875	2000		
W 80				770 - 780		765 - 775	2000		

Aquarius UNI N 120, 100, 90

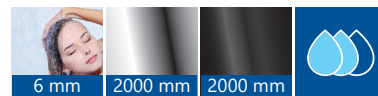

153

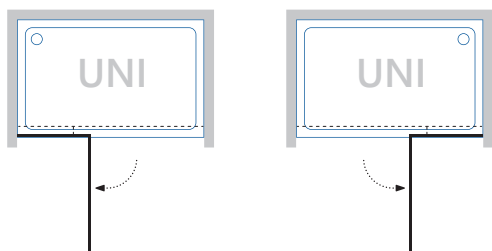

N 120, 100, 90

- Samostojna tuš vrata, enostransko odpiranje.
- Self-supporting shower door, single-side opening.
- Samostojeća tuš vrata, jednostrano otvaranje.
- Samostojeća tuš vrata, jednostrano otvaranje.

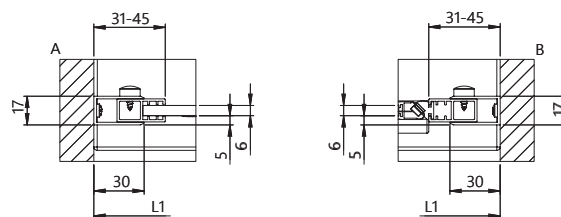
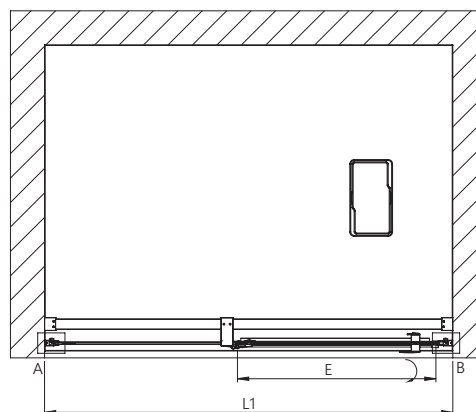

Hopp, Menora, Menora zero, Ballo, Tello, Moonwalk, Re-walk, Tobas, Capo, Serra, Canary, Drop, Flamenco, Evelin Tray Q, Trin.

Aquarius UNI			L1	L2	X1	X2		E	
N 120			1180 - 1200				2000	565	
N 100			980 - 1000				2000	525	
N 90			880 - 900				2000	525	



2000 mm

8 mm

CALYPSO UNI



Družine tuš kabin in njihove značilnosti

A range of shower enclosures and their characteristics

Skupine tuš-kabina i njihove karakteristike

Asortiman tuš kabina i njihove karakteristike



8 mm KALJENO PROZORNO STEKLO

8 mm transparent tempered glass

8 mm kaljeno prozorno staklo

8 mm prozorno kaljeno staklo

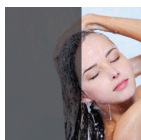

8 mm GRAPHITE KALJENO PROZORNO STEKLO

8 mm graphite transparent tempered glass

8 mm graphite kaljeno prozorno staklo

8 mm graphite prozorno kaljeno staklo



8 mm MIRROR STEKLO

8 mm mirror glass

8 mm miror staklo

8 mm mirror staklo



SBR

2000 mm SILVER BRILL PROFILI (VISOKOPOLIRANA SREBRNA GALVANSKA PREVLEKA)

2000 mm Silver Brill Profiles (high gloss-polished silver galvanised coating)

2000 mm Silver Brill profili (visokopolirana srebrna galvanska prevlaka)

2000 mm Silver Brill profili (visokopolirani srebrni galvanski premaz)

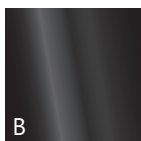

B

2000 mm BLACK (ČRNI) PROFILI, PRAŠNO LAKIRANJE

2000 mm BLACK profiles, powder coating

2000 mm BLACK (crni) profili, lakiranje prahom

2000 mm BLACK (crni) profili, suvo lakiranje



GOLD

2000 mm GOLD (ZLATI) PROFILI, BRUŠEN

2000 mm GOLD profiles, grinded

2000 mm GOLD (zlatni) profili, brušen

2000 mm GOLD (zlatni) profili, brušen



OPORA ZA STABILNOST TUŠ KABINE

support for the stability of the shower enclosure

podpora za stabilnost tuš kabine

oslonac za stabilnost tuš kabine

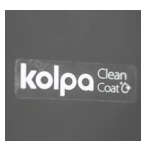

kolpa Clean Coat

CLEAN COAT, ZAŠČITNI PREMAZ

Clean coat, protective coating

Clean coat, zaščitni premaz

Clean coat, zaščitni premaz



TUŠ KABINA PO MERI

Custom shower cabin

Tuš kabina po mjeri

Tuš kabina po meri



Calypso UNI WO

Calypso UNI WO 140, 120, 100



156

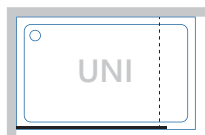

WO 140, 120, 100

- **Tuš stena** z možnostjo postavitve na tuš kad ali direktno na tla (brez tuš kadi).
- **Shower wall** that can either be installed on a shower tray or directly on the floor (shower tray not required).
- **Tuš stijena** s možnostjo postavljanja na tuš kadu ili izravno na tlo (bez tuš kade).
- **Tuš stena** sa mogućnošću montaže na tuš kadu ili direktno na pod (bez tuš kade).

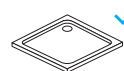
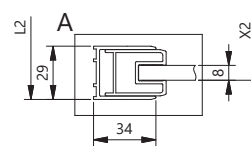
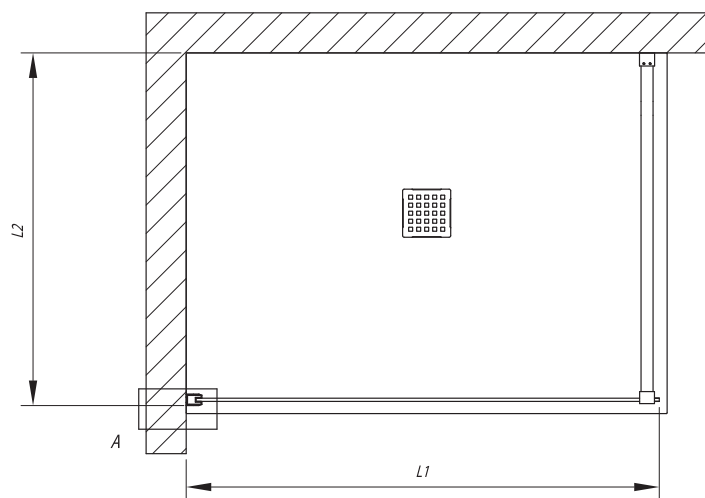

Hopp, Menora, Menora zero, Ballo, Tello, Moonwalk,
Re-walk, Capo, Canary, Serra, Tobas,
Drop, Flamenco, Evelin Tray Q.

Calypso UNI			L1	L2	X1	X2		E	
WO 140			1380 - 1390	max 1200			2000		
WO 120			1180 - 1190	max 1200			2000		
WO 100			980 - 990	max 1200			2000		

Calypso UNI WO 140, 120, 100

































 GOLD (zlati) profili, brušen
GOLD profiles, grinded
GOLD (zlatni) profili, brušen
GOLD (zlatni) profili, brušen

 Black
Black
Black
Black

 Srebrna Brill (SBR)
Silver Brill (SBR)
Srebrna Brill (SBR)
Srebrna Brill (SBR)

PROFILI / PROFILES

STEKLO / GLASS

WO 140-UNI GOLD CALYPSO				
WO 120-UNI GOLD CALYPSO				
WO 100-UNI GOLD CALYPSO				
WO 140-UNI B CALYPSO				
WO 120-UNI B CALYPSO				
WO 100-UNI B CALYPSO				
WO 140-UNI SBR CALYPSO				
WO 120-UNI SBR CALYPSO				
WO 100-UNI SBR CALYPSO				

 Kaljeno prozorno steklo (1)
Tempered transparent glass (1)
Kajleno prozorno staklo (1)
Kajleno providno staklo (1)

 Graphite kajjeno steklo (3)
Graphite tempered glass (3)
Graphite kajjeno staklo (3)
Graphite kajjeno staklo (3)

 Mirror steklo (5)
Mirror glass (5)
Mirror staklo (5)
Mirror staklo (5)

 Clean coat, zaščitni premaz
Clean coat, protective coating
Clean coat, zaščitni premaz
Clean coat, zaščitni premaz



8 mm



2000 mm



8 mm



LIBRA



Družine tuš kabin in njihove značilnosti

A range of shower enclosures and their characteristics

Skupine tuš-kabina i njihove karakteristike

Asortiman tuš kabina i njihove karakteristike



8 mm KALJENO PROZORNO STEKLO

8 mm transparent tempered glass
8 mm kaljeno prozorno staklo
8 mm prozorno kaljeno staklo



SBR

2000 mm SILVER BRILL PROFILI (VISOKOPOLIRANA SREBRNA GALVANSKA PREVLEKA)

Silver Brill Profiles (high gloss-polished silver galvanised coating)
Silver Brill profili (visokopolirana srebrna galvanska prevlaka)
Silver Brill profili (visokopolirani srebrni galvanski premaz)

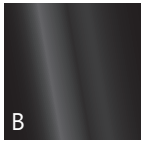

B

2000 mm BLACK (ČRNI) PROFILI, PRAŠNO LAKIRANJE

BLACK profiles, powder coating
BLACK (crni) profili, lakiranje prahom
BLACK (crni) profili, suvo lakiranje



ZAPIRANJE Z MAGNETNIM PROFILOM

magnetic closure
zatvaranje s magnetnim profilom
zatvaranje pomoću magnetnog profila



SKRITI LEŽAJI KABINE, ZAŠČITENI PRED VODNIM KAMNOM

hidden cabin bearings, protected from limescale
skriveni ležajevi kabine, zaščiteni od kamenca
skriveni ležajevi kabine, zaščiteni od kamenca



DODATNI ALUMINIJASTI PROFIL NA TUŠ KADI PREPREČUJE IZTEKANJE VODE

an additional shower door threshold prevents overflow
dodatni aluminijasti profil na tuš kadi sprječava istjecanje vode
dodatni aluminijumski profil na tuš kadi sprečava izlivanje vode



kolpa Clean Coat

CLEAN COAT, ZAŠČITNI PREMAZ

Clean coat, protective coating
Clean coat, zaštitni premaz
Clean coat, zaštitni premaz



TUŠ KABINA PO MERI

Custom shower cabin
Tuš kabina po mjeri
Tuš kabina po meri

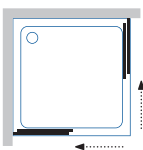

Libra Q



Libra N -L



Libra N -R

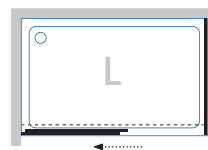

Libra DW -L

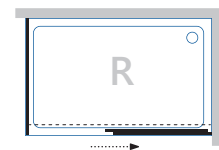

Libra DW -R

Libra Q 100, 90

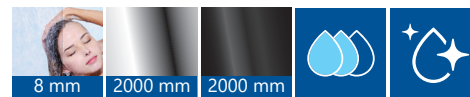

160

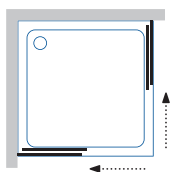

Q 100, 90

- Kotna tuš kabina, drsno odpiranje z dvema kriloma
- Corner shower enclosure, double-wing sliding opening
- Kutna tuš kabina, klizno otvaranje s dva vratna krila
- Ugaona tuš kabina, klizno otvaranje sa dva krila

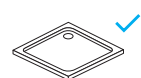
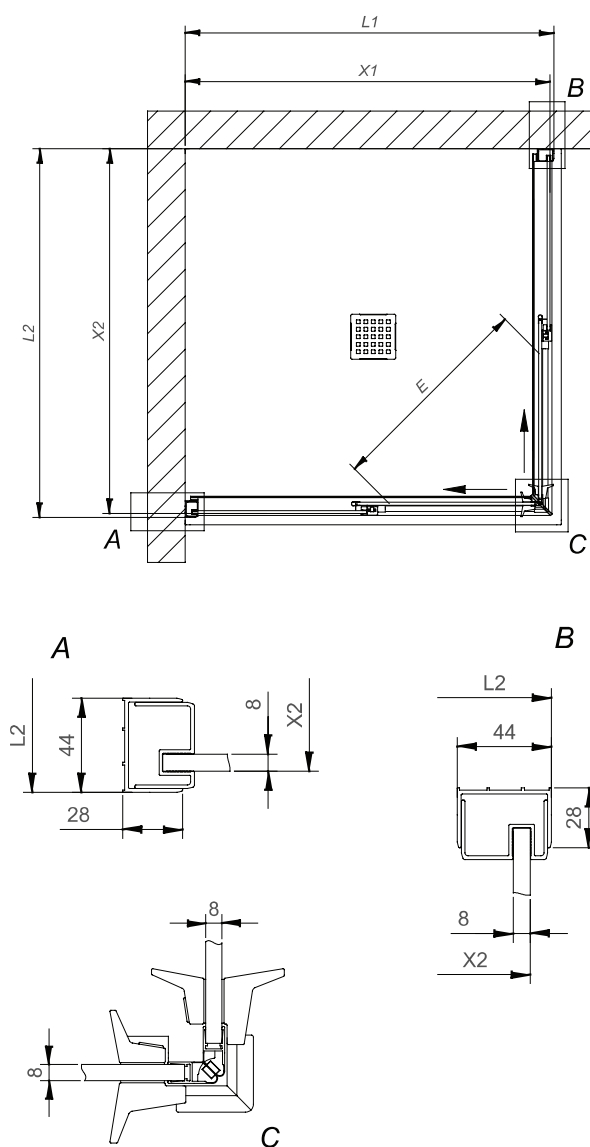

Menora Zero, Menora, Hopp, Tello, Moonwalk, Tobas, Serra, Capo, Canary, Drop, Flamenco, Evelin Tray Q, Trin

Libra			L1	L2	X1	X2		E	
Q 100			980 - 990	980 - 990	970 - 980	970 - 980	2000	555	
Q 90			880 - 890	880 - 890	870 - 880	870 - 880	2000	480	

Libra Q 100, 90

Libra N 140, 120, 100 - L, R

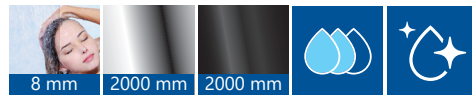

8 mm

2000 mm

2000 mm



161

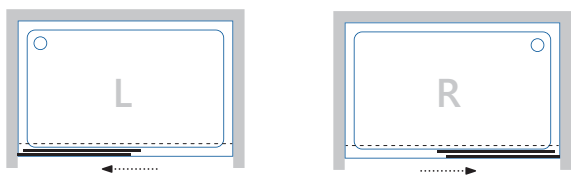

N 140, 120, 100

- Samostojna tuš vrata, levo ali desno drsno odpiranje
- Self-supporting shower door, left or right-side sliding opening
- Samostojeća tuš vrata, lijevo ili desno klizno otvaranje
- Samostojeća tuš vrata, levo ili desno klizno otvaranje

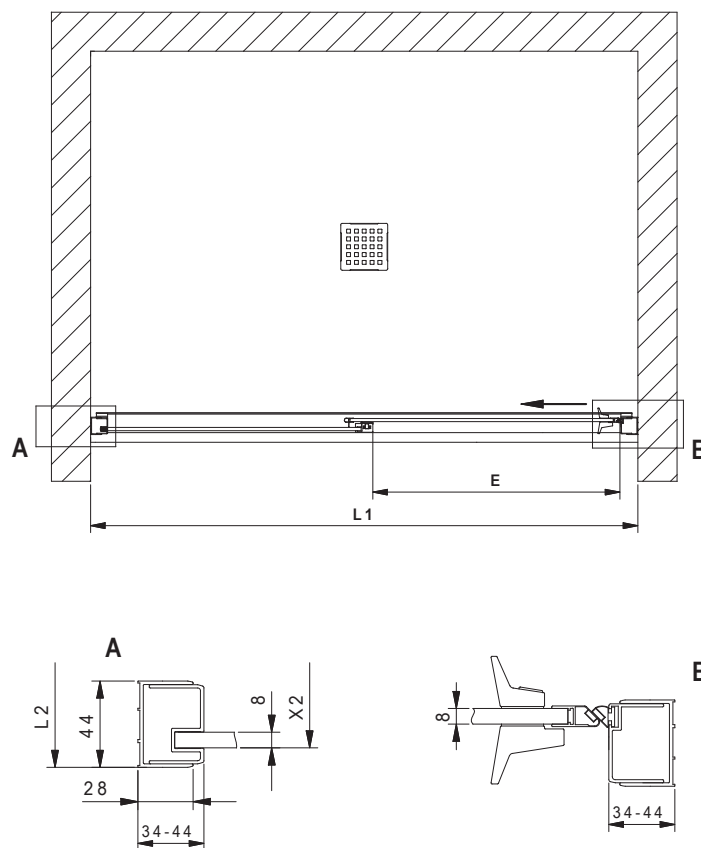

Libra N 140, 120, 100

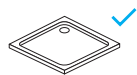

Hopp, Menora, Menora zero, Ballo, Tello, Moonwalk, Re-walk, Tobas, Capo, Serra, Canary, Drop, Flamenco, Evelin Tray Q, Trin

Libra			L1	L2	X1	X2		E	
N 140 -L, R			1380 - 1400				2000	585	
N 120 -L, R			1180 - 1200				2000	485	
N 100 -L, R			980 - 1000				2000	385	

Libra DW 140, 120, 100 - L, R

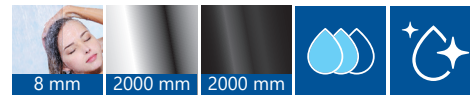

162

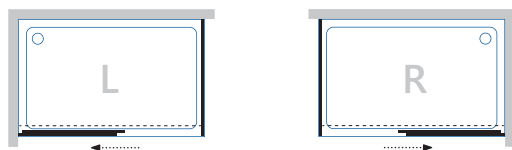

DW 140, 120, 100

- Tuš vrata s tuš steno, levo ali desno drsno odpiranje
- Shower door with shower wall, left or right-side sliding opening
- Tuš vrata s tuš stijenom, lijevo ili desno klizno otvaranje
- Tuš vrata sa tuš stenom, levo ili desno klizno otvaranje.

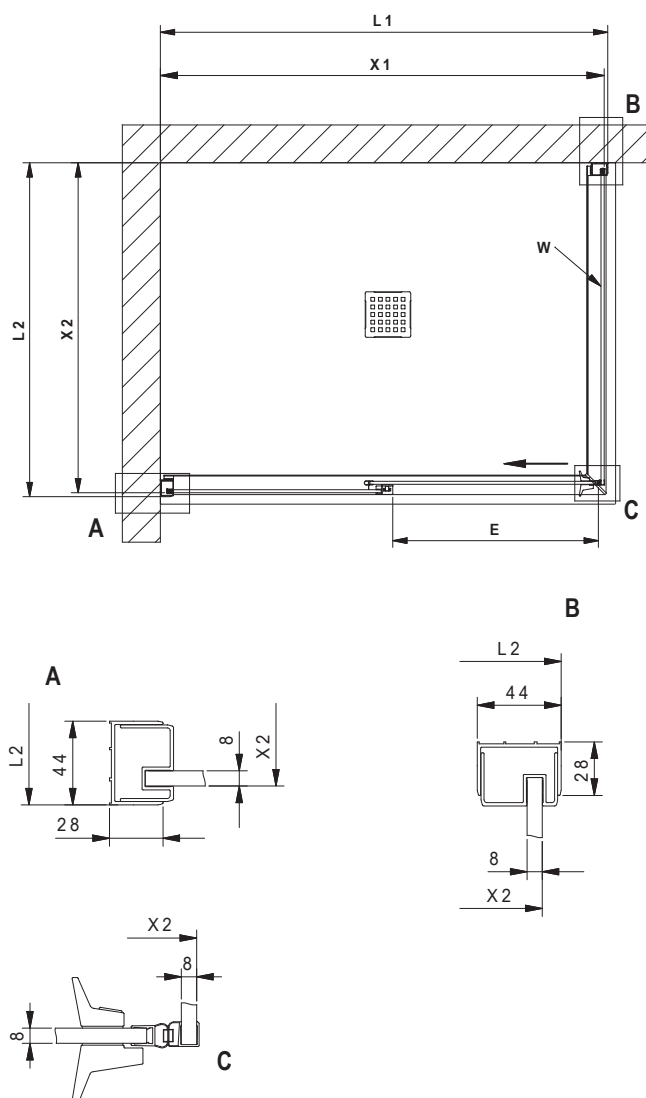

Hopp, Menora, Menora zero, Ballo, Tello, Moonwalk, Re-walk, Tobas, Capo, Canary, Serra, Drop, Flamenco, Evelin Tray Q, Trin.

Libra			L1	L2	X1	X2		E	
DW 140 x 90 -L, R			1380 - 1390	880 - 890	1370 - 1380	870 - 880	2000	600	
DW 140 x 80 -L, R			1380 - 1390	780 - 790	1370 - 1380	770 - 780	2000	600	
DW 120 x 100 -L, R			1180 - 1190	980 - 990	1170 - 1180	970 - 980	2000	500	
DW 120 x 90 -L, R			1180 - 1190	880 - 890	1170 - 1180	870 - 880	2000	500	
DW 120 x 80 -L, R			1180 - 1190	780 - 790	1170 - 1180	770 - 780	2000	500	
DW 100 x 100 -L, R			980 - 990	980 - 990	970 - 980	970 - 980	2000	405	
DW 100 x 90 -L, R			980 - 990	880 - 890	970 - 980	870 - 880	2000	405	
DW 100 x 80 -L, R			980 - 990	780 - 790	970 - 980	770 - 780	2000	405	



164



8 mm



8 mm



VIRGO UNI

2000 mm





Družine tuš kabin in njihove značilnosti

A range of shower enclosures and their characteristics

Skupine tuš-kabina i njihove karakteristike

Asortiman tuš kabina i njihove karakteristike



8 mm KALJENO PROZORNO STEKLO

8 mm transparent tempered glass

8 mm kaljeno prozorno staklo

8 mm prozirno kaljeno staklo



SBR

2000 mm SILVER BRILL PROFILI (VISOKOPOLIRANA SREBRNA GALVANSKA PREVLEKA)

2000 mm Silver Brill Profiles (high gloss-polished silver galvanised coating)

2000 mm Silver Brill profili (visokopolirana srebrna galvanska prevlaka)

2000 mm Silver Brill profili (visokopolirani srebrni galvanski premaz)

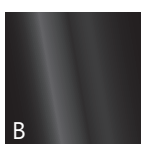

B

2000 mm BLACK (ČRNI) PROFILI, PRAŠNO LAKIRANJE

2000 mm BLACK profiles, powder coating

2000 mm BLACK (crni) profili, lakiranje prahom

2000 mm BLACK (crni) profili, suvo lakiranje



ZAPIRANJE Z MAGNETNIM PROFILOM

magnetic closure

zatvaranje s magnetnim profilom

zatvaranje pomoću magnetnog profila



VRATNO KRILO NA MASIVNIH KROGLIČNIH LEŽAJIH

door wing on solid ball bearings

vratno krilo na masivnim kugličnim ležajevima

krilo vrata na masivnim kugličnim ležajevima

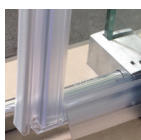

DEMONTAŽNI ČEP OMOGOČA LAŽJE ČIŠČENJE

mounting plug allows easier cleaning

demontažni čep omogočuje lažše čiščenje

demontažni čep omogočava lažše čiščenje

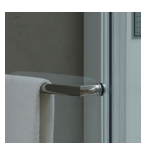

DRŽALO ZA BRISAČE

towel holder

držač ručnika

držač za peškire



DODATNI ALUMINIJASTI PROFIL NA TUŠ KADI PREPREČUJE IZTEKANJE VODE

an additional shower door threshold prevents overflow

dodatni aluminijaski profil na tuš kadi sprječava istjecanje vode

dodatni aluminijumski profil na tuš kadi sprečava izlivanje vode

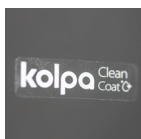

CLEAN COAT, ZAŠČITNI PREMAZ

Clean coat, protective coating

Clean coat, zaščitni premaz

Clean coat, zaščitni premaz

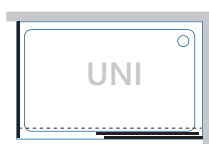

Virgo UNI TK

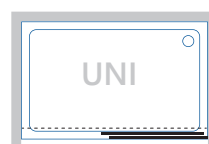

Virgo UNI TV2D/S

Virgo UNI TK 160, 140, 120

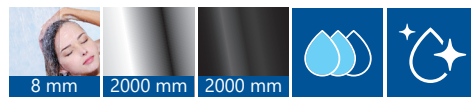

166

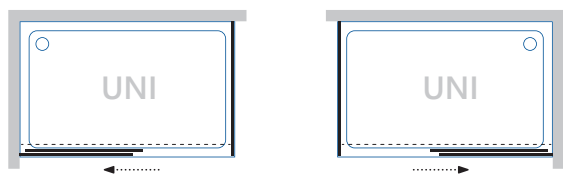

TK 160, 140, 120

- Tuš kabina - vrata in stena, levo ali desno enostransko odpiranje.
- Shower enclosure - door and wall, left or right-side opening.
- Tuš kabina - vrata i stijena, lijevo ili desno jednostrano otvaranje.
- Tuš kabina-vrata i stena,levo ili desno jednostrano otvaranje.

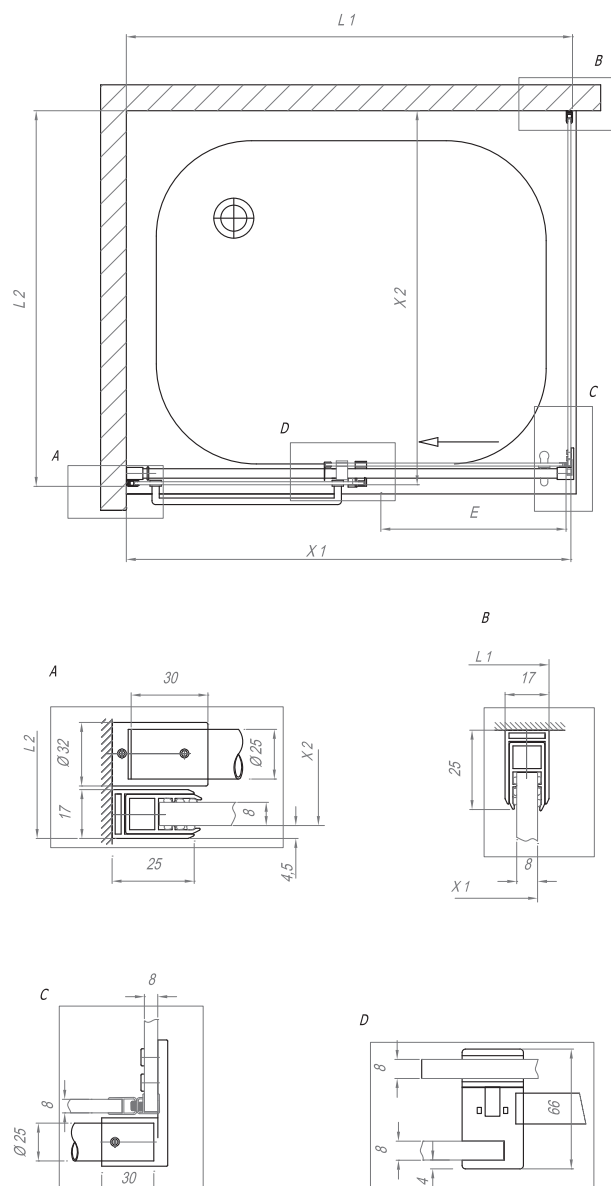

Virgo UNI TK 160, 140, 120

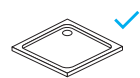

Hopp, Menora, Menora zero, Ballo, Tello, Moonwalk, Re-walk, Capo, Canary, Serra, Tobas, Drop, Flamenco, Evelin Tray Q.

Virgo UNI			L1	L2	X1	X2		E		
TK 160 x 90			1585 - 1590	890 - 895	1580 - 1585	885 - 890		2000	660	
TK 160 x 80			1585 - 1590	790 - 795	1580 - 1585	785 - 790		2000	660	
TK 140 x 90			1385 - 1390	890 - 895	1380 - 1385	885 - 890		2000	560	
TK 140 x 80			1385 - 1390	790 - 795	1380 - 1385	785 - 790		2000	560	
TK 120 x 90			1185 - 1190	890 - 895	1180 - 1185	885 - 890		2000	460	
TK 120 x 80			1185 - 1190	790 - 795	1180 - 1185	785 - 790		2000	460	

Virgo UNI TV2D/S 160, 140, 120

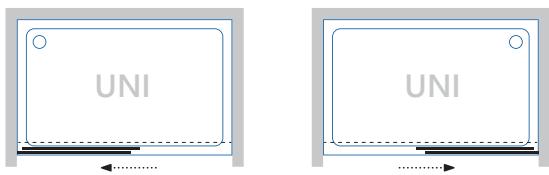
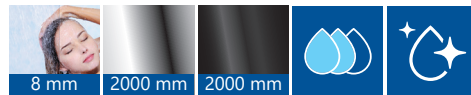

TV2D/S 160, 140, 120

- Samostojna tuš vrata, enostransko odpiranje.
- Self-supporting shower door, single-side opening.
- Samostojeća tuš vrata, jednostrano otvaranje.
- Samostojeća tuš vrata, jednostrano otvaranje.

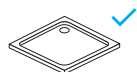
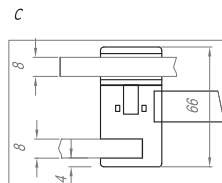
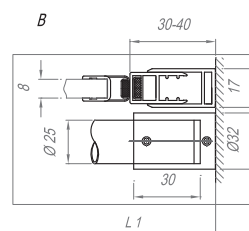
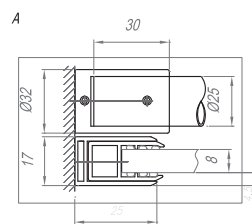
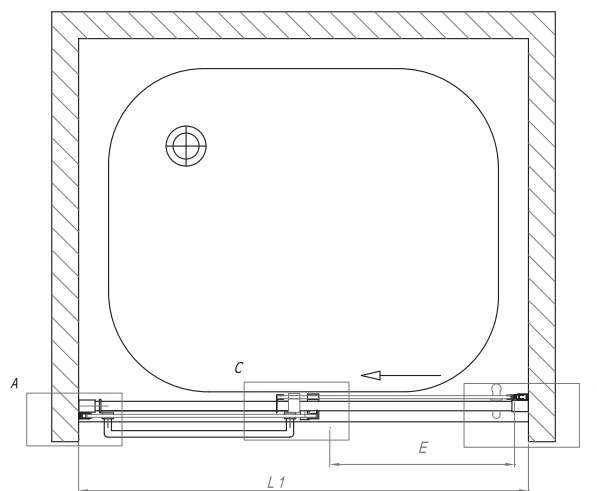

Hopp, Menora, Menora zero, Ballo, Tello, Moonwalk, Re-walk, Capo, Canary, Serra, Tobas, Drop, Flamenco, Evelin Tray Q.

Virgo UNI			L1	L2	X1	X2		E	
TV2D/S 160			1580 - 1600				2000	660	
TV2D/S 140			1380 - 1400				2000	560	
TV2D/S 120			1180 - 1200				2000	460	



6 mm



2000 mm



STELLAR UNI



Družine tuš kabin in njihove značilnosti

A range of shower enclosures and their characteristics

Skupine tuš-kabina i njihove karakteristike

Asortiman tuš kabina i njihove karakteristike



6 mm KALJENO PROZORNO STEKLO

6 mm transparent tempered glass

6 mm kaljeno prozorno staklo

6 mm prozorno kaljeno staklo



SBR

2000 mm SILVER BRILL PROFILI (VISOKOPOLIRANA SREBRNA GALVANSKA PREVLEKA)

2000 mm Silver Brill Profiles (high gloss-polished silver galvanised coating)

2000 mm Silver Brill profili (visokopolirana srebrna galvanska prevlaka)

2000 mm Silver Brill profili (visokopolirani srebrni galvanski premaz)

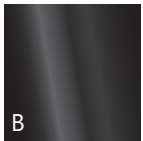

B

2000 mm BLACK (ČRNI) PROFILI, PRAŠNO LAKIRANJE

2000 mm BLACK profiles, powder coating

2000 mm BLACK (crni) profili, lakiranje prahom

2000 mm BLACK (crni) profili, suvo lakiranje



ZAPIRANJE Z MAGNETNIM PROFILOM

magnetic closure

zatvaranje s magnetskim profilom

zatvaranje pomoću magnetnog profila



DRSNO-ROTIRAJOČA VRATA, OMOGOČAJO VELIKO VHODNO ODPRTINO

sliding-rotating doors, allowing a large entrance opening

klizno-rotirajuća vrata, omogočujući veliki ulazni otvor

klizna-rotirajuća vrata, omogućava veliki ulazni otvor



SNEMNLJIVA VRATNA KRILA OMOGOČAJO LAŽJE ČIŠČENJE

detachable door panels for easy cleaning

vratna krila za skidanje omogočuju lakše čiščenje

vratna krila sa mogućnošću skidanja omogućavaju lakše čiščenje



PRIKAZ ODPIRANJA KABINE

shower enclosure opening

prikaz otvaranja kabine

prikaz otvaranje kabine

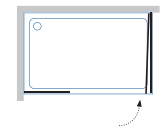
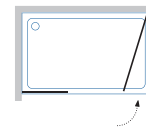
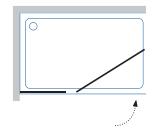
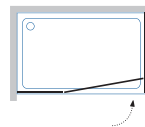
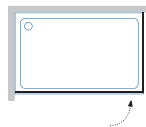

Stellar UNI DW

Stellar UNI DW 120x90, 120x80, 90x90

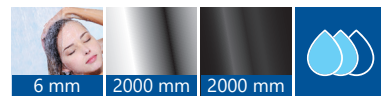

170

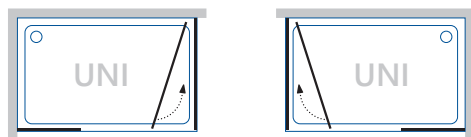

DW 120x90, 120x80, 90x90

- Tuš kabina - vrata in stena, drsno odpiranje
- Shower enclosure - door and wall, sliding opening
- Tuš kabina - vrata i stijena, klizno otvaranje
- Tuš kabina - vrata i stena, klizno otvaranje

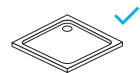
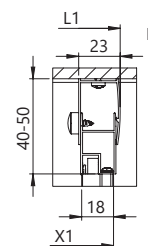
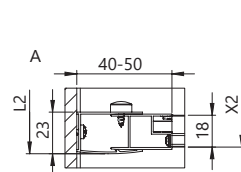
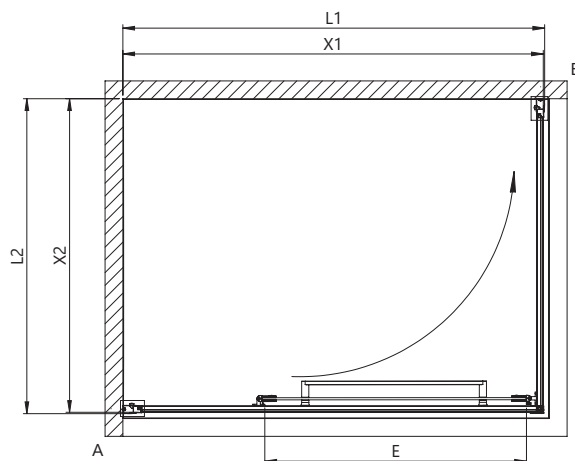

Hopp, Menora, Menora zero, Tello, Moonwalk, Tobas, Capo, Canary, Drop, Serra, Flamenco, Evelin Tray Q, Trin.

Stellar UNI			L1	L2	X1	X2		E	
DW 120x90			1180 - 1190	880 - 890	1176 - 1186	876 - 886	2000	710	
DW 120x80			1180 - 1190	780 - 790	1176 - 1186	776 - 786	2000	610	
DW 90x90			880 - 890	880 - 890	876 - 886	876 - 886	2000	560	

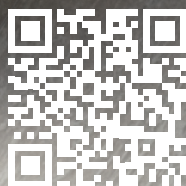

Video odpiranja kabine
Video of the shower enclosure opening
Video otvaranja kabine
Video otvaranja kabine

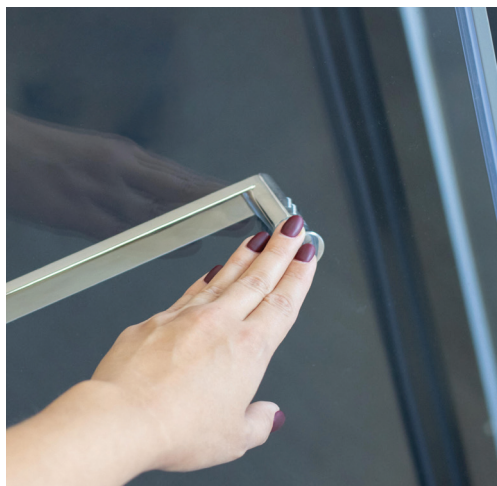
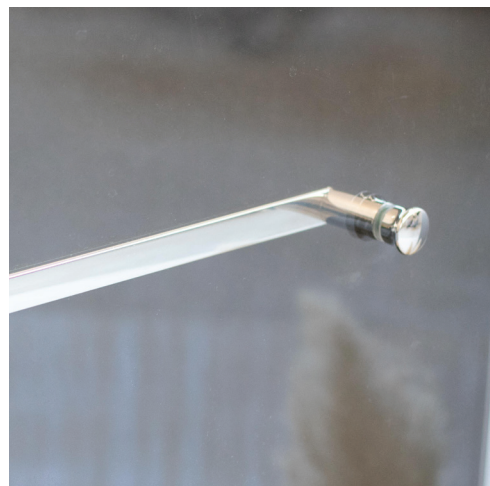



6 mm

2000 mm



VENUS UNI



Družine tuš kabin in njihove značilnosti

A range of shower enclosures and their characteristics

Skupine tuš-kabina i njihove karakteristike

Asortiman tuš kabina i njihove karakteristike



6 mm KALJENO PROZORNO STEKLO

6 mm transparent tempered glass
6 mm kaljeno prozorno staklo
6 mm prozorno kaljeno staklo



6 mm CHINCHILLA KALJENO STEKLO

6 mm chinchilla tempered glass
6 mm chinchilla prozorno staklo
6 mm chinchilla kaljeno staklo



WH

2000 mm WHITE (BELI) PROFILI, PRAŠNO LAKIRANJE

2000 mm WHITE profiles, powder coating
2000 mm WHITE (beli) profili, lakiranje prahom
2000 mm WHITE (beli) profili, suvo lakiranje



S

2000 mm SILVER PROFILI (SREBRNA GALVANSKA PREVLEKA)

2000 mm Silver Profiles (silver galvanised coating)
2000 mm Silver profili (srebrna galvanska prevlaka)
2000 mm Silver profili (srebrni galvanski premaz)

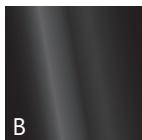

B

2000 mm BLACK (ČRNI) PROFILI, PRAŠNO LAKIRANJE

2000 mm BLACK profiles, powder coating
2000 mm BLACK (crni) profili, lakiranje prahom
2000 mm BLACK (crni) profili, suvo lakiranje

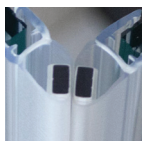

ZAPIRANJE Z MAGNETNIM PROFILOM

magnetic closure
zatvaranje s magnetnim profilom
zatvaranje pomoću magnetnog profila



SNEMLJIVA VRATNA KRILA OMOGOČAJO LAŽJE ČIŠČENJE

detachable door panels for easy cleaning
mogućnost postavljanja dodatnih kompenzacijskih profila
vratna krila sa mogućnošću skidanja omogućavaju lakše čišćenje

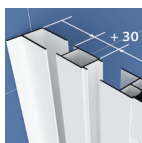

MOŽNOST KOMPENZACIJSKEGA PROFILA K 30 – ZA Q, R, D, W IN N

optional compensation Profiles K 30 – for Q, R, D, W and N
mogućnost kompenzacijskog profila K 30 – za Q, R, D, W i N
mogućnost kompenzatornog profila K 30 – za Q, R, D, W i NS

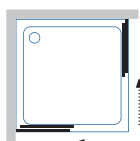

Venus UNI Q

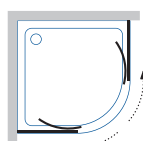

Venus UNI R



Venus UNI D + D

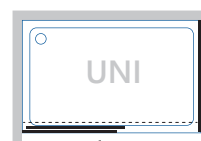

Venus UNI D + W

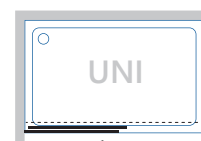

Venus UNI N 120, 110, 100



Venus UNI N 170, 160, 140

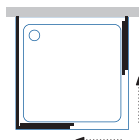

Venus UNI D + D + WU



Venus UNI
N 120, 110, 100 + 2x WU



Venus UNI
N 170, 160, 140 + 2x WU

Venus UNI Q 90, 80

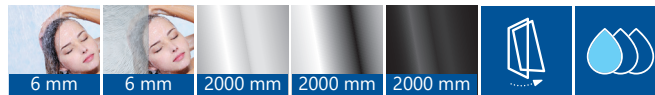

174

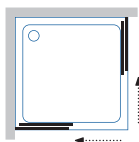

Venus UNI Q 90, 80

- Kotna tuš kabina, drsno odpiranje z dvema kriloma
- Corner shower enclosure, double-wing sliding opening
- Kutna tuš kabina, klizno otvaranje s dva vratna krila
- Četvrtasta tuš kabina, klizno otvaranje sa dva krila

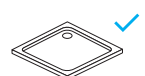
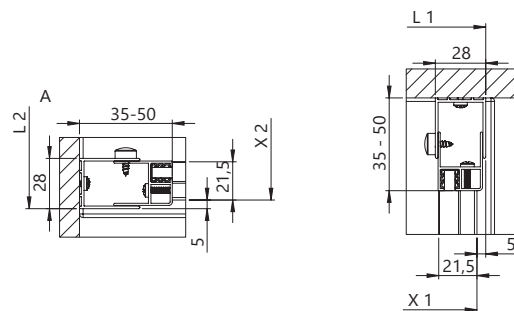
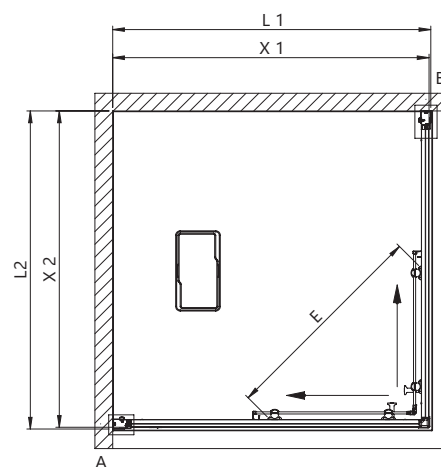

Hopp, Menora, Menora zero, Tello, Moonwalk, Serra, Tobas, Capo, Canary, Drop, Flamenco, Evelin Tray Q, Trin.

Venus UNI			L1	L2	X1	X2		E	
Q 90			880 - 895	880 - 895	875 - 890	875 - 890	2000	465	
Q 80			780 - 795	780 - 795	775 - 790	775 - 790	2000	400	

Venus UNI R 120x90, 100x80, 100, 90, 80

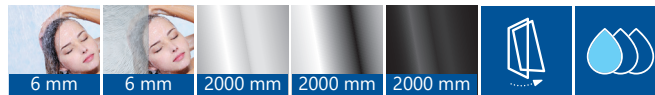
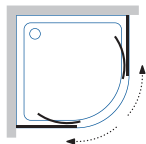

175



Venus UNI R 120x90, 100x80, 100, 90, 80

- Polkrožna tuš kabina, drsno odpiranje z dvema kriloma
- Semi-circular shower enclosure, double-wing sliding opening
- Polukružna tuš kabina, klizno odpiranje s dva vratna krila
- Polukružna tuš kabina, klizno odpiranje sa dva krila

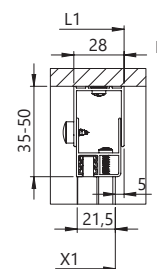
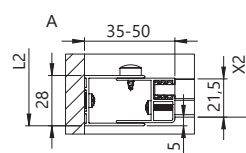
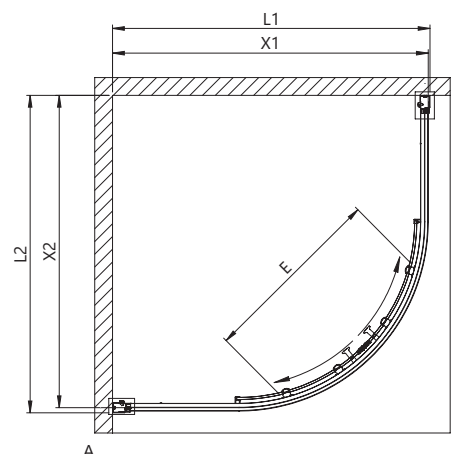

Hopp R, Menora R, Moonwalk R, Macarena, Drop R, Evelin Tray R, Ontex, Malur.

Venus UNI R 120 x 90, 100 x 80, 90, 80

Venus UNI			L1	L2	X1	X2		E	
R 120 x 90			1180 - 1195	880 - 895	1175 - 1190	875 - 890	2000	540	
R 100 x 80			980 - 995	780 - 795	975 - 990	775 - 790	2000	450	
R 100			980 - 995	980 - 995	975 - 990	975 - 990	2000	450	
R 90			880 - 895	880 - 895	875 - 890	875 - 890	2000	540	
R 80			780 - 795	780 - 795	775 - 790	775 - 790	2000	450	

Venus UNI D 170, 160, 140, 120, 110, 100, 90, 80, 70 + D 170, 160, 140, 120, 110, 100, 90, 80, 70

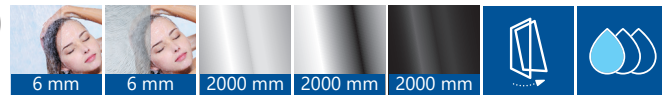

176

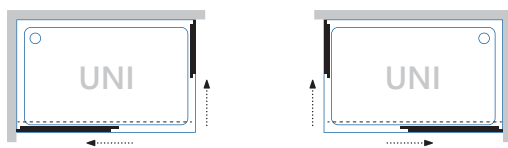

Venus UNI D 170, 160, 140, 120, 110, 100, 90, 80, 70 + D 170, 160, 140, 120, 110, 100, 90, 80, 70

- tuš vrata + tuš vrata, drsno odpiranje z dvema kriloma
- shower doors + shower doors, double-wing sliding opening
- tuš vrata + tuš vrata, klizno odpiranje s dva vratna krila
- tuš vrata + tuš vrata, klizno odpiranje sa dva krila

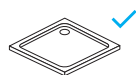
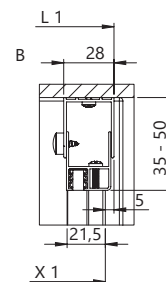
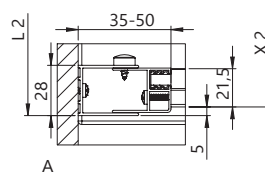
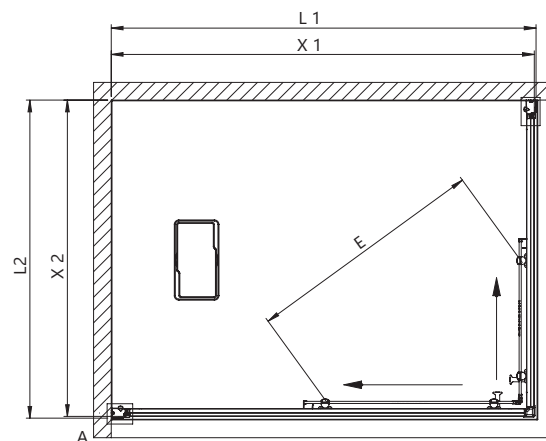

Hopp, Menora, Menora zero, Tello, Moonwalk, Serra, Tobas, Capo, Canary, Drop, Ballo, Flamenco, Evelin Tray Q, Trin.

Venus UNI D + D

	D 70	D 80	D 90	D 100	D 110	D 120	D 140	D 160	D 170
D 70			•	•	•	•	•	•	•
D 80		•	•	•	•	•	•	•	•
D 90	•	•	•	•	•	•	•	•	•
D 100	•	•	•	•	•	•	•	•	•
D 110	•	•	•	•					
D 120	•	•	•	•					
D 140	•	•	•	•					
D 160	•	•	•	•					
D 170	•	•	•	•					

Venus UNI D + D

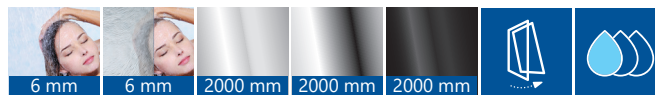

Venus UNI D + D			L1	L2	X1	X2		E	
D 170 + D 100			1680 - 1695	980 - 995	1675 - 1690	975 - 990	2000	815	
D 170 + D 90			1680 - 1695	880 - 895	1675 - 1690	875 - 890	2000	795	
D 170 + D 80			1680 - 1695	780 - 795	1675 - 1690	775 - 790	2000	770	
D 170 + D 70			1680 - 1695	680 - 695	1675 - 1690	675 - 690	2000	755	
Venus UNI D + D			L1 	L2 	X1 	X2 		E 	
D 160 + D 100			1580 - 1595	980 - 995	1575 - 1590	975 - 990	2000	770	
D 160 + D 90			1580 - 1595	880 - 895	1575 - 1590	875 - 890	2000	750	
D 160 + D 80			1580 - 1595	780 - 795	1575 - 1590	775 - 790	2000	725	
D 160 + D 70			1580 - 1595	680 - 695	1575 - 1590	675 - 690	2000	710	
Venus UNI D + D			L1 	L2 	X1 	X2 		E 	
D 140 + D 100			1380 - 1395	980 - 995	1375 - 1390	975 - 990	2000	690	
D 140 + D 90			1380 - 1395	880 - 895	1375 - 1390	875 - 890	2000	660	
D 140 + D 80			1380 - 1395	780 - 795	1375 - 1390	775 - 790	2000	635	
D 140 + D 70			1380 - 1395	680 - 695	1375 - 1390	675 - 690	2000	615	
Venus UNI D + D			L1 	L2 	X1 	X2 		E 	
D 120 + D 100			1180 - 1195	980 - 995	1175 - 1190	975 - 990	2000	605	
D 120 + D 90			1180 - 1195	880 - 895	1175 - 1190	875 - 890	2000	575	
D 120 + D 80			1180 - 1195	780 - 795	1175 - 1190	775 - 790	2000	550	
D 120 + D 70			1180 - 1195	680 - 695	1175 - 1190	675 - 690	2000	525	
Venus UNI D + D			L1 	L2 	X1 	X2 		E 	
D 110 + D 100			1080 - 1095	980 - 995	1075 - 1090	975 - 990	2000	570	
D 110 + D 90			1080 - 1095	880 - 895	1075 - 1090	875 - 890	2000	535	
D 110 + D 80			1080 - 1095	780 - 795	1075 - 1090	775 - 790	2000	505	
D 110 + D 70			1080 - 1095	680 - 695	1075 - 1090	675 - 690	2000	480	
Venus UNI D + D			L1 	L2 	X1 	X2 		E 	
D 100 + D 170			980 - 995	1680 - 1695	975 - 990	1675 - 1690	2000	815	
D 100 + D 160			980 - 995	1580 - 1595	975 - 990	1575 - 1590	2000	770	
D 100 + D 140			980 - 995	1380 - 1395	975 - 990	1375 - 1390	2000	690	
D 100 + D 120			980 - 995	1180 - 1195	975 - 990	1175 - 1190	2000	605	
D 100 + D 110			980 - 995	1080 - 1095	975 - 990	1075 - 1090	2000	570	
D 100 + D 100			980 - 995	980 - 995	975 - 990	975 - 990	2000	500	
D 100 + D 90			980 - 995	880 - 895	975 - 990	875 - 890	2000	500	
D 100 + D 80			980 - 995	780 - 795	975 - 990	775 - 790	2000	465	
D 100 + D 70			980 - 995	680 - 695	975 - 990	675 - 690	2000	434	
Venus UNI D + D			L1 	L2 	X1 	X2 		E 	
D 90 + D 170			880 - 895	1680 - 1695	875 - 890	1675 - 1690	2000	795	
D 90 + D 160			880 - 895	1580 - 1595	875 - 890	1575 - 1590	2000	750	
D 90 + D 140			880 - 895	1380 - 1395	875 - 890	1375 - 1390	2000	660	
D 90 + D 120			880 - 895	1180 - 1195	875 - 890	1175 - 1190	2000	575	
D 90 + D 110			880 - 895	1080 - 1095	875 - 890	1075 - 1090	2000	535	
D 90 + D 100			880 - 895	980 - 995	875 - 890	975 - 990	2000	500	
D 90 + D 90			880 - 895	880 - 895	875 - 890	875 - 890	2000	460	
D 90 + D 80			880 - 895	780 - 795	875 - 890	775 - 790	2000	425	
D 90 + D 70			880 - 895	680 - 695	875 - 890	675 - 690	2000	395	
Venus UNI D + D			L1 	L2 	X1 	X2 		E 	
D 80 + D 170			780 - 795	1680 - 1695	775 - 790	1675 - 1690	2000	770	
D 80 + D 160			780 - 795	1580 - 1595	775 - 790	1575 - 1590	2000	725	
D 80 + D 140			780 - 795	1380 - 1395	775 - 790	1375 - 1390	2000	635	
D 80 + D 120			780 - 795	1180 - 1195	775 - 790	1175 - 1190	2000	550	
D 80 + D 110			780 - 795	1080 - 1095	775 - 790	1075 - 1090	2000	505	
D 80 + D 100			780 - 795	980 - 995	775 - 790	975 - 990	2000	465	
D 80 + D 90			780 - 795	880 - 895	775 - 790	875 - 890	2000	425	
D 80 + D 80			780 - 795	780 - 795	775 - 790	775 - 790	2000	390	
Venus UNI D + D			L1 	L2 	X1 	X2 		E 	
D 70 + D 170			680 - 695	1680 - 1695	675 - 690	1675 - 1690	2000	755	
D 70 + D 160			680 - 695	1580 - 1595	675 - 690	1575 - 1590	2000	710	
D 70 + D 140			680 - 695	1380 - 1395	675 - 690	1375 - 1390	2000	615	
D 70 + D 120			680 - 695	1180 - 1195	675 - 690	1175 - 1190	2000	525	
D 70 + D 110			680 - 695	1080 - 1095	675 - 690	1075 - 1090	2000	480	
D 70 + D 100			680 - 695	980 - 995	675 - 690	975 - 990	2000	434	
D 70 + D 90			680 - 695	880 - 895	675 - 690	875 - 890	2000	395	

Venus UNI D 170, 160, 140, 120, 110, 100 + W 100, 90, 80, 70

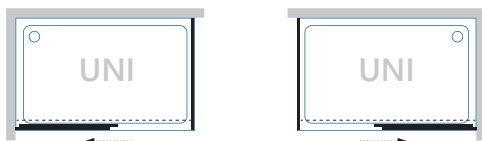
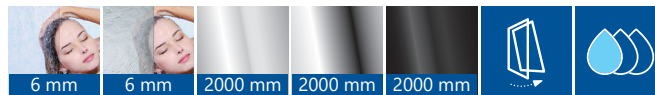

Venus UNI D 170, 160, 140, 120, 110, 100 + W 100, 90, 80, 70

- Kotna tuš kabina, drsno odpiranje z dvema kriloma
- Corner shower enclosure, double-wing sliding opening
- Kutna tuš kabina, klizno otvaranje s dva vratna krila
- Tuš vrata + tuš stena, klizno otvaranje jednog krila

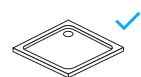
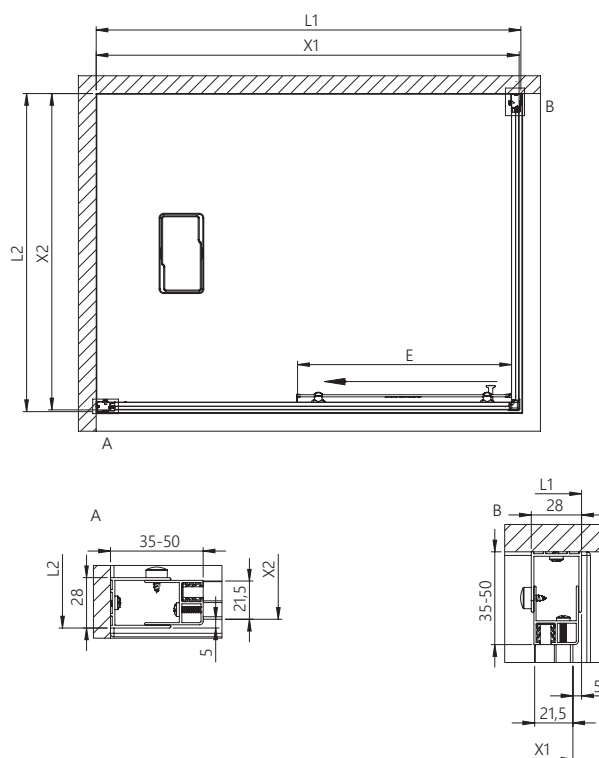

Hopp, Menora, Menora zero, Tello, Moonwalk, Serra, Tobas, Capo, Canary, Drop, Ballo, Flamenco, Evelin Tray Q.

Venus UNI			L1	L2	X1	X2			
D 170			1680 - 1695		1675 - 1690		2000	745	
D 160			1580 - 1595		1575 - 1590		2000	695	
D 140			1380 - 1395		1375 - 1390		2000	595	
D 120			1180 - 1195		1175 - 1190		2000	495	
D 110			1080 - 1095		1075 - 1090		2000	445	
D 100			980 - 995		975 - 990		2000	395	
W 100				990 - 995		975 - 990	2000		
W 90				880 - 895		875 - 890	2000		
W 80				780 - 795		775 - 790	2000		
W 70				680 - 695		675 - 690	2000		



Venus UNI N 120, 110, 100

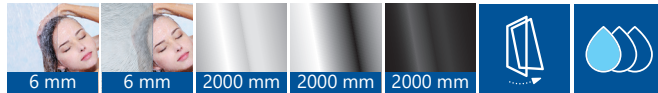

180

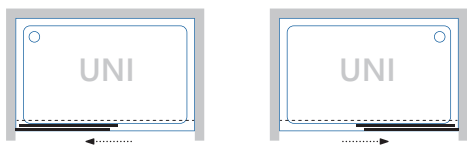

Venus UNI N 120, 110, 100

- Samostojna dvodelna tuš vrata, enostransko odpiranje.
- Self-supporting two-piece shower door, single-side opening.
- Samostojeća dvodijelna tuš vrata, jednostrano otvaranje.
- Samostojeća dvodelna tuš vrata, jednostrano otvaranje.

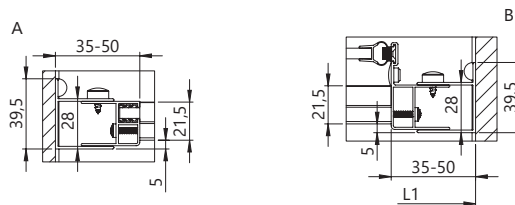
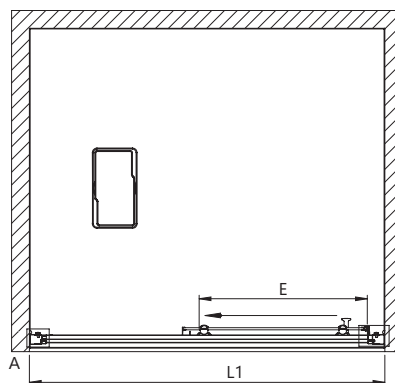

Venus UNI N 120, 110, 100

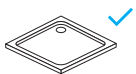

Hopp, Menora, Menora zero, Tello, Moonwalk, Tobas, Capo, Canary, Serra, Drop, Flamenco, Evelin Tray Q.

Venus UNI			L1	L2	X1	X2		E	
N 120			1175 - 1200				2000	500	
N 110			1075 - 1100				2000	440	
N 100			975 - 1000				2000	390	

Venus UNI N 170, 160, 140

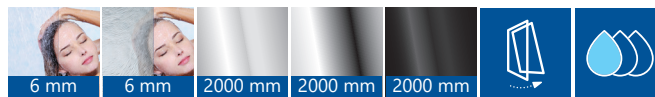

181



Venus UNI N 170, 160, 140

- Samostojna štiridelna tuš vrata, sredinsko odpiranje.
- Self-supporting four-piece shower door, central opening.
- Samoatoječa četverodijelna tuš vrata, dvostrano otvaranje.
- Samostojeća tuš vrata, dvostrano klizno otvaranje.

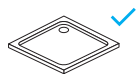
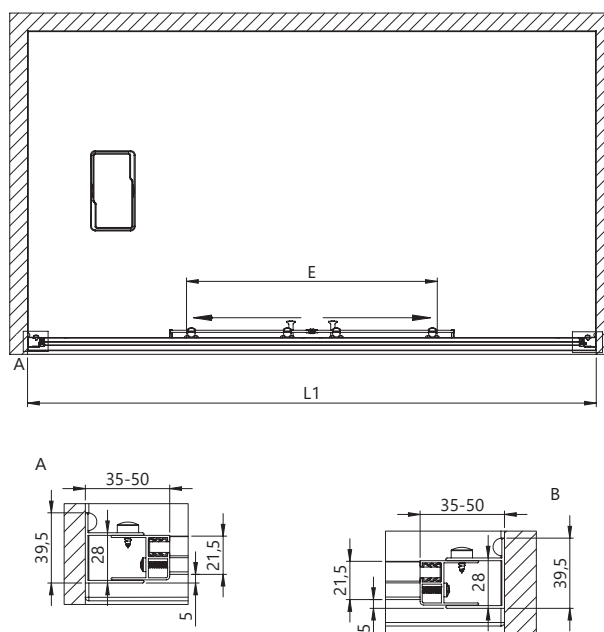

Hopp, Menora, Menora zero, Tello, Moonwalk, Tobas, Capo, Canary, Drop, Ballo, Flamenco.

Venus UNI N 170, 160, 140

Venus UNI			L1	L2	X1	X2		E	
N 170			1675 - 1700				2000	680	
N 160			1575 - 1600				2000	590	
N 140			1375 - 1400				2000	540	

Venus UNI D 170, 160, 140, 120, 110, 100, 90, 80, 70 + D 90, 80, 70 + WU 90, 80, 70

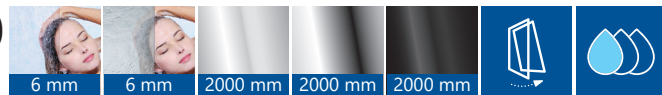

182

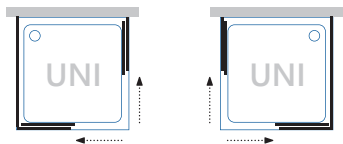

Venus UNI D 170, 160, 140, 120, 110, 100, 90, 80, 70 + D 90, 80, 70 + WU 90, 80, 70

- tuš vrata + tuš vrata + U stena, drsno odpiranje z dvema kriloma
- shower doors + shower doors + U wall, double-wing sliding opening
- tuš vrata + tuš vrata + U stijena, klizno otvaranje s dva vratna krila
- tuš vrata + tuš vrata + U stena, klizno otvaranje sa dva krila

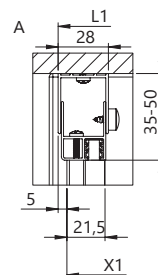
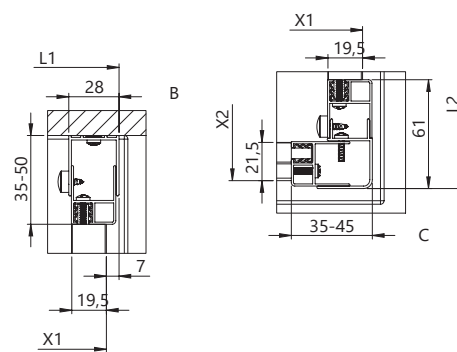
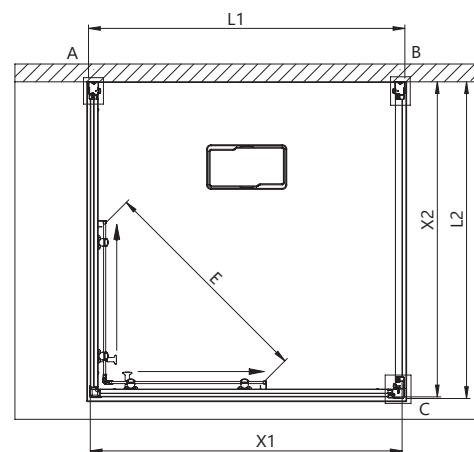

Venus UNI D 170, 160, 140, 120, 110, 100, 90, 80, 70 + D 90, 80, 70 + WU 90, 80, 70

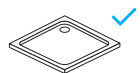

Hopp, Menora, Menora zero, Tello, Moonwalk, Serra, Tobas, Capo, Canary, Drop, Ballo, Flamenco, Evelin Tray Q, Trin.

Venus UNI D + D + WU

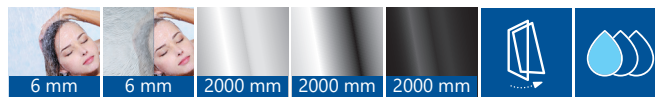

Venus UNI			L1	L2	X1	X2		E	
D 90 + D 170			1680 - 1690		1668 - 1678		2000	795	
D 90 + D 160			1580 - 1590		1568 - 1578		2000	750	
D 90 + D 140			1386 - 1390		1368 - 1378		2000	660	
D 90 + D 120			1180 - 1190		1168 - 1178		2000	575	
D 90 + D 110			1080 - 1090		1068 - 1078		2000	535	
D 90 + D 100			980 - 990		968 - 978		2000	500	
D 90 + D 90			880 - 890		868 - 878		2000	460	
D 90 + D 80			780 - 790		768 - 778		2000	425	
D 90 + D 70			680 - 690		668 - 678		2000	395	
WU 90				880 - 895		875 - 890	2000		

Venus UNI			L1	L2	X1	X2		E	
D 80 + D 170			1680 - 1690		1668 - 1678		2000	770	
D 80 + D 160			1580 - 1590		1568 - 1578		2000	725	
D 80 + D 140			1386 - 1390		1368 - 1378		2000	635	
D 80 + D 120			1180 - 1190		1168 - 1178		2000	550	
D 80 + D 110			1080 - 1090		1068 - 1078		2000	505	
D 80 + D 100			980 - 990		968 - 978		2000	465	
D 80 + D 90			880 - 890		868 - 878		2000	425	
D 80 + D 80			780 - 790		768 - 778		2000	390	
WU 80				780 - 795		775 - 790	2000		

Venus UNI			L1	L2	X1	X2		E	
D 70 + D 170			1680 - 1690		1668 - 1678		2000	755	
D 70 + D 160			1580 - 1590		1568 - 1578		2000	710	
D 70 + D 140			1380 - 1390		1368 - 1378		2000	615	
D 70 + D 120			1180 - 1190		1168 - 1178		2000	525	
D 70 + D 110			1080 - 1090		1068 - 1078		2000	480	
D 70 + D 100			980 - 990		968 - 978		2000	434	
D 70 + D 90			880 - 890		868 - 878		2000	395	
WU 70				680 - 695		675 - 690	2000		



Venus UNI N 120, 110, 100 + 2xWU 90, 80, 70

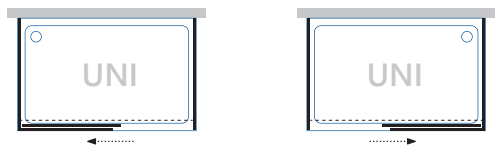
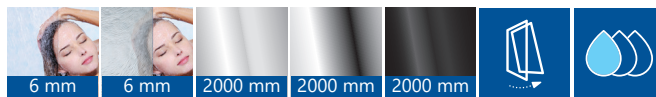

Venus UNI N 120, 110, 100 + 2xWU 90, 80, 70

- Samostojna dvodelna tuš vrata + 2x stena, enostransko odpiranje.
- Self-supporting two-piece shower door + 2x wall, single-side opening.
- Samostojeća dvodijelna tuš vrata + 2x stijena, jednostrano otvaranje.
- Samostojeća dvodelna tuš vrata + 2x stena, jednostrano otvaranje.

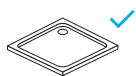
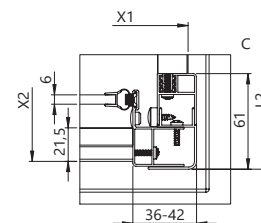
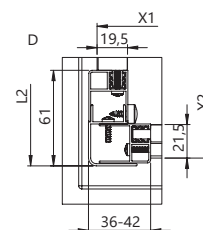
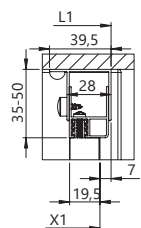
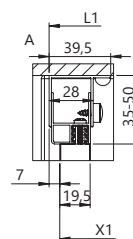
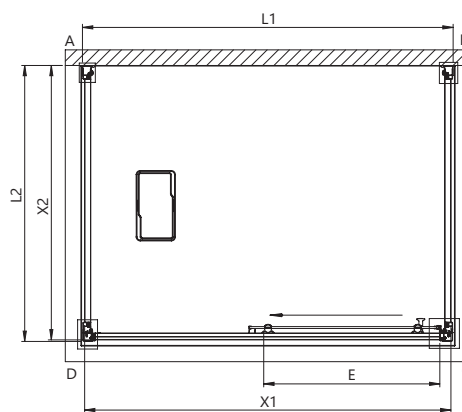

Hopp, Menora, Menora zero, Tello, Moonwalk, Serra, Tobas, Capo, Canary, Drop, Flamenco, Evelin Tray Q.

Venus UNI			L1	L2	X1	X2		E	
N 120			1180 - 1195		1166 - 1181		2000	500	
N 110			1080 - 1195		1066 - 1081		2000	440	
N 100			980 - 995		980 - 995		2000	390	
WU 90				880 - 895		875 - 890	2000		
WU 80				780 - 795		775 - 790	2000		
WU 70				680 - 695		675 - 690	2000		



Venus UNI N 170, 160, 140 + 2xWU 90, 80, 70



Venus UNI N 170, 160, 140 + 2x WU 90, 80, 70

- Samostojna štiridelna tuš vrata + 2x stena, sredinsko odpiranje.
- Self-supporting four-piece shower door + 2x wall, central opening.
- Samotoječa četverodijelna tuš vrata + 2x stijena, dvostrano otvaranje.
- Samostojna četvorodelna tuš vrata + 2x stena, dvostrano klizno otvaranje.

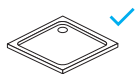
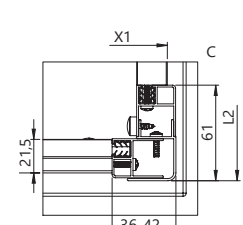
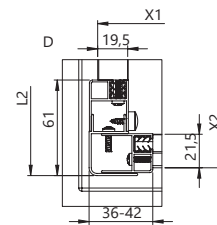
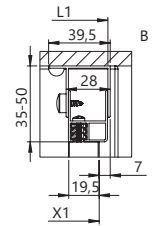
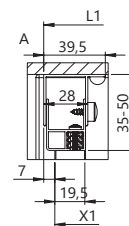
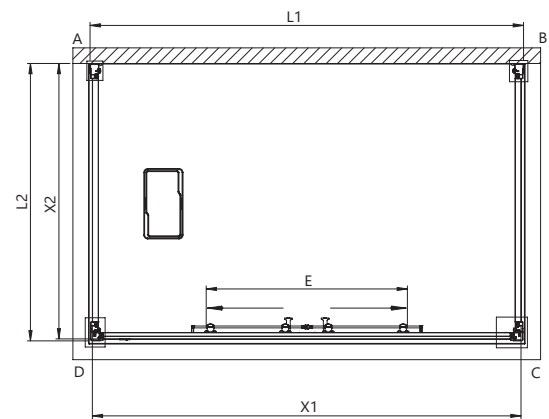

Hopp, Menora, Menora zero, Tello, Moonwalk, Tobas, Capo, Canary, Drop, Ballo, Flamenco, Evelin Tray Q.

Venus UNI			L1	L2	X1	X2		E	
N 170			1680 - 1695		1666 - 1681		2000	680	
N 160			1580 - 1595		1566 - 1581		2000	590	
N 140			1380 - 1395		1366 - 1381		2000	540	
WU 90				880 - 895		875 - 890	2000		
WU 80				780 - 795		775 - 790	2000		
WU 70				680 - 695		675 - 690	2000		

Dodatni profili

Additional profiles

Dodatni profili

Dodatni profili

186



Dodatni profil za izvedbo nestandardnih dimenzij kabin po širini.

Različica s kompenzacijskim profilom K 30
– za Q, R, N, D in W

Additional profiles for fitting nonstandard dimension enclosure widths.

The variant with the compensational profile K 30 – for Q, R, N, D in W

Dodatni profil za podešavanje izvan-standardnih dimenzija kabina po širini.

Varijanta s kompenzacijskim profilom K 30
– za Q, R, N, D i W

Dodatni profil za ugradnju nestandardnih dimenzija kabina po širini.

Varijanta sa kompenzacionim profilom K 30
– za Q, R, N, D i W

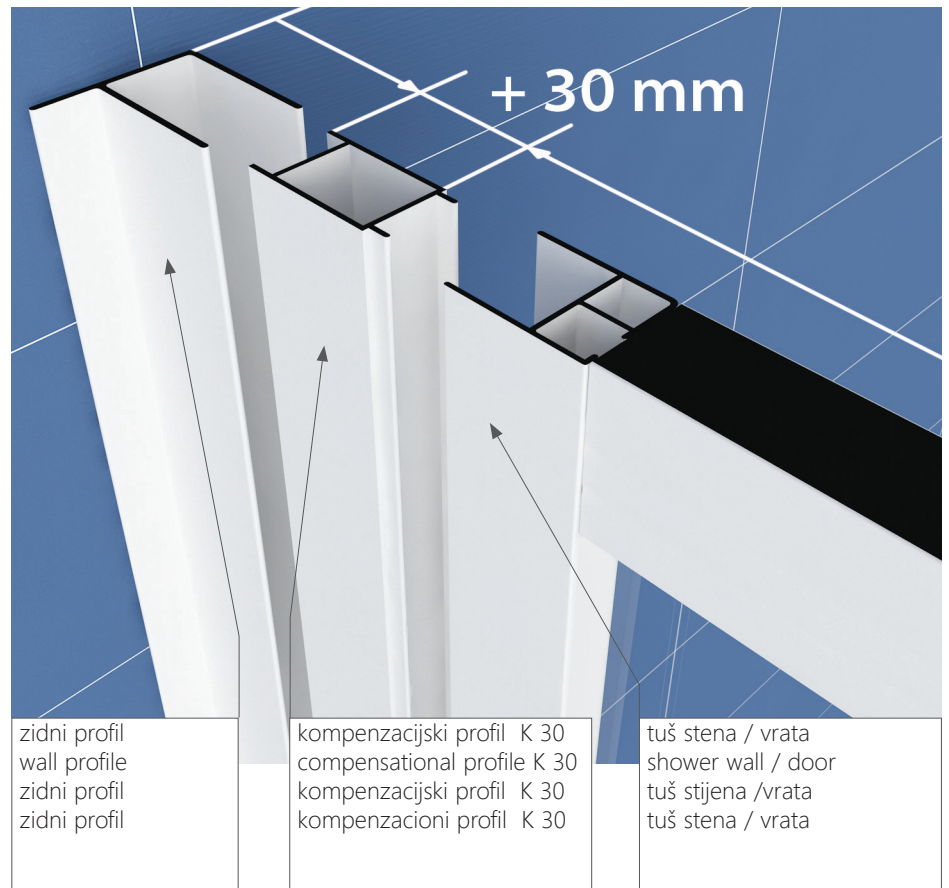

zidni profil
wall profile
zidni profil
zidni profil

kompenzacijski profil K 30
compensational profile K 30
kompenzacijski profil K 30
kompenzacioni profil K 30

tuš stena / vrata
shower wall / door
tuš stijena /vrata
tuš stena / vrata

Tip /Type		Vrsta profila / Type of profile		
K-30 B Profil		dodatni profil za Q, R, N, D in W additional profile Q, R, N, D and W	2000	30
K-30 SBR Profil		dodatni profil za Q, R, N, D in W additional profile Q, R, N, D and W	2000	30
K-30 WH Profil		dodatni profil za Q, R, N, D in W additional profile Q, R, N, D and W	2000	30





4 mm



1900 mm
1850 mm



LUNA UNI





Družine tuš kabin in njihove značilnosti

A range of shower enclosures and their characteristics

Skupine tuš-kabina i njihove karakteristike

Asortiman tuš kabina i njihove karakteristike

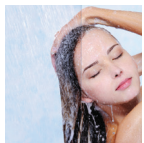

4/6 mm KALJENO PROZORNO STEKLO

4/6 mm transparent tempered glass

4/6 mm kaljeno prozirno staklo

4/6 mm prozirno kaljeno staklo



1850/1900 mm SILVER PROFILI (SREBRNA GALVANSKA PREVLEKA)

1850/1900 mm Silver Profiles (silver galvanised coating)

1850/1900 mm Silver profili (srebrna galvanska prevlaka)

1850/1900 mm Silver profili (srebrni galvanski premaz)



ZAPIRANJE Z MAGNETNIM PROFILOM

magnetic closure

zatvaranje s magnetnim profilom

zatvaranje pomoću magnetnog profila

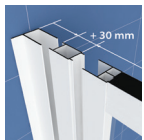

MOŽNOST KOMPENZACIJSKEGA PROFILA K 30 – ZA TV3D/S, TVZ/S

optional compensation Profiles K 30 for TV3D/S, TVZ/S

možnost kompenzacijskog profila K 30 – za TV3D/S, TVZ/S

možnost kompenzatornog profila K 30 – za TV3D/S, TVZ/S

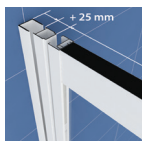

MOŽNOST KOMPENZACIJSKEGA PROFILA K 25 – ZA TVO/S

optional compensation Profiles K 25 for TVO/S

možnost kompenzacijskog profila K 25 – za TVO/S

možnost kompenzatornog profila K 25 – za TVO/S



Luna UNI TV3D/S



Luna UNI
TV3D/S + TSv

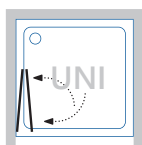

Luna UNI TVZ/S

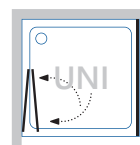

Luna UNI
TVZ/S + TSvZ

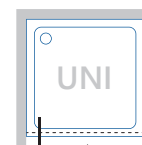

Luna UNI TVO/S

Luna UNI TV3D/S 100, 90, 80



190

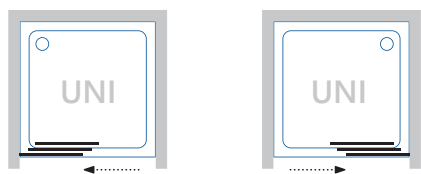

TV3D/S 100, 90, 80

- Samostojna tuš vrata, tridelna. Možnost vgradnje dodatnega profila K 30 za izvedbo nestandardnih dimenzij kabin po širini.
- Freestanding shower cabin, threefold.
- Optional K 30 profile for non-standard cabin widths.
- Samotoječa tuš vrata, rtodjelná. Mogućnost ugradnje dodatnog profila K 30 za izvedbu nestandardnih dimenzija kabina po širini.
- Samostojéca trodelna tuš vrata. Mogućnost ugradnje dodatnog profila K 30 za izvodjenje nestandardnih dimenzija kabina po širini.

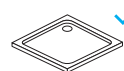
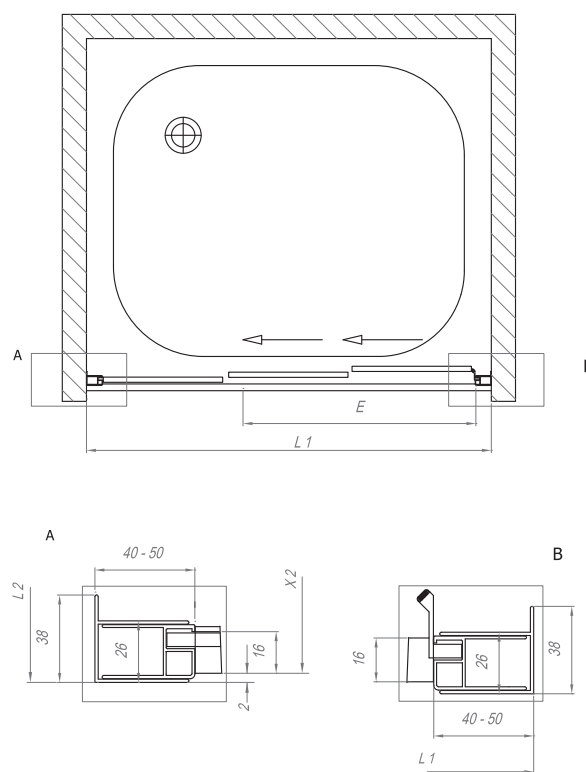

Menora Zero, Menora, Hopp, Tello, Moonwalk, Capo, Canary, Serra, Tobas, Drop, Flamenco, Evelin Tray Q, Trin.

Luna UNI			L1	L2	X1	X2		E	
TV3D/S 100			980 - 1000				1850	500	
TV3D/S 90			880 - 900				1850	430	
TV3D/S 80			780 - 800				1850	370	

Luna UNI TV3D/S + TSv3D 90, 80

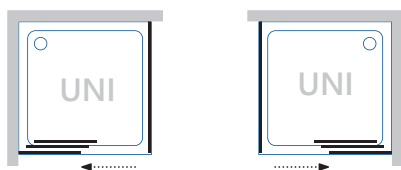
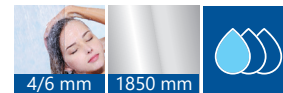

TV3D/S + TSv3D 90, 80

- Samostojna tuš vrata, tridelna, s tuš steno. Možnost vgradnje dodatnega profila K 30 za izvedbo nestandardnih dimenzij kabin po širini..
- Freestanding shower cabin, threefold with shower wall.
- Optional K 30 profile for non-standard cabin widths.
- Tuš vrata trodjelna, s tuš stijenom. Mogućnost ugradnje dodatnog profila K 30 za izvedbu nestandardnih dimenzija kabina po širini.
- Samostojeća trodelna tuš vrata+tuš stena.Mogućnost ugradnje dodatnog profila K 30 za izvodjenje nastandardnih dimenzija kabina po širini.

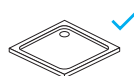
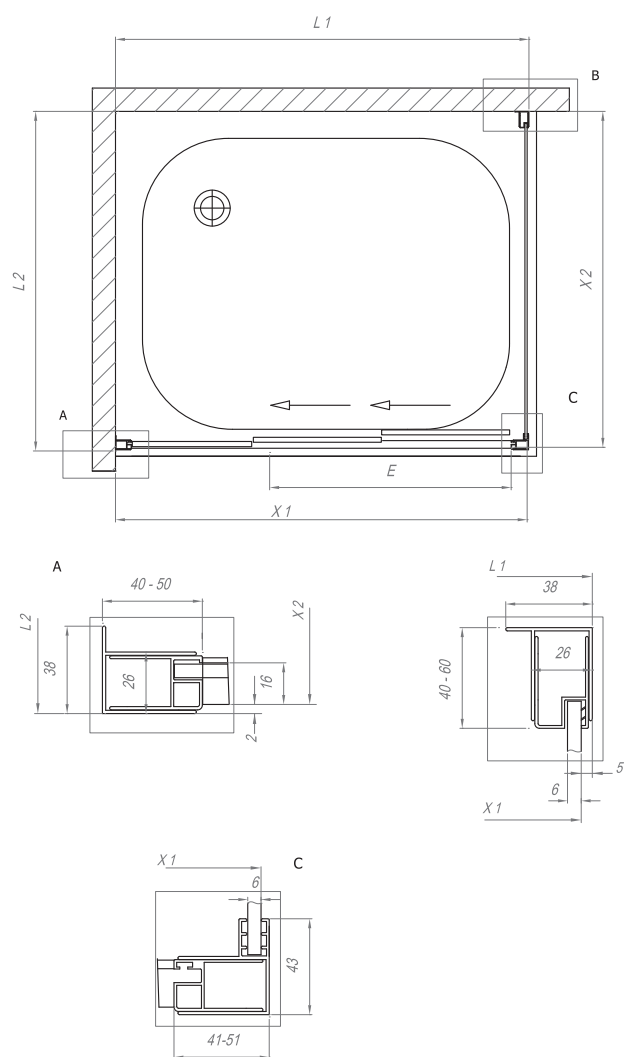

Menora Zero, Menora, Hopp, Serra, Tobas, Tello, Moonwalk, Canary, Drop, Flamenco, Evelin Tray Q, Trin.

Luna UNI			L1	L2	X1	X2		E	
TV3D/S 100			980 - 1000		975 - 995		1850	500	
TV3D/S 90			880 - 900		875 - 895		1850	430	
TV3D/S 80			780 - 800		775 - 795		1850	370	
TSv3D 90				875 - 895		873 - 893	1850		
TSv3D 80				775 - 795		773 - 793	1850		

Luna UNI TVZ/S 90, 80

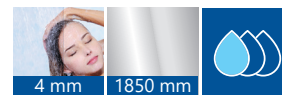

192

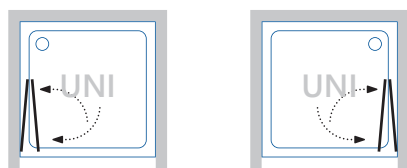

TVZ/S 90, 80

- Samostojna tuš vrata z zložljivima kriloma. Možnost vgradnje dodatnega profila K 30 za izvedbo nestandardnih dimenzij kabin po širini..
- Freestanding shower door with foldable wings.
- Optional K 30 profile for non-standard cabin widths.
- Samostojeća tuš vrata sklopiva. Mogućnost ugradnje dodatnog profila K 30 za izvedbu nestandardnih dimenzija kabina po širini.
- Samostojeća tuš vrata sa sklopivim krilima. Mogućnost ugradnje dodatnog profila K 30 za izvođenje nestandardnih dimenzija kabina po širini.

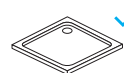
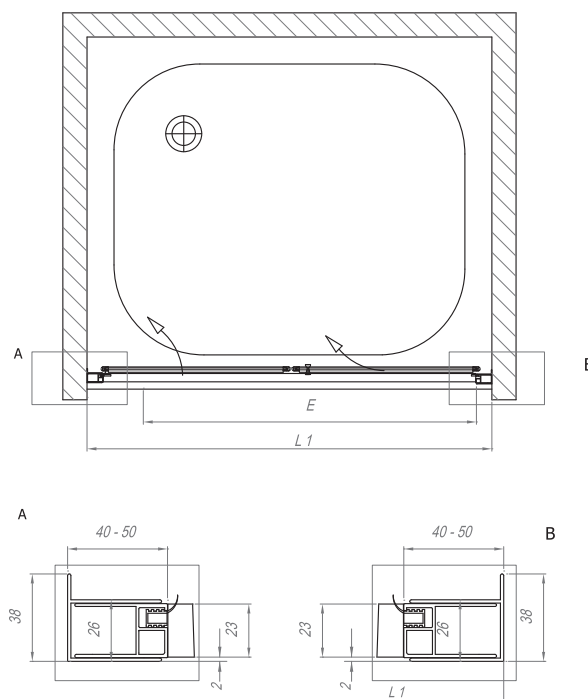

Menora Zero, Menora, Hopp, Tello, Moonwalk, Serra, Tobas, Capo, Canary, Drop, Flamenco, Evelin Tray Q, Trin.

Luna UNI			L1	L2	X1	X2		E	
TVZ/S 90			880 - 900				1850	670	
TVZ/S 80			780 - 800				1850	570	

Luna UNI TVZ/S 90, 80 + TSvZ 90, 80

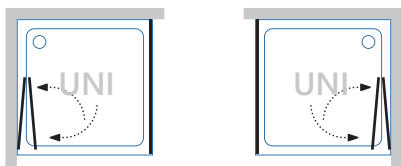

TVZ/S 90, 80 + TSvZ 90, 80

- Samostojna tuš vrata z zložljivima kriloma s tuš steno. Možnost vgradnje dodatnega profila K 30 za izvedbo nestandardnih dimenzij kabin po širini.
- Freestanding shower door with foldable wings with shower wall. Optional K 30 profile for non-standard cabin widths.
- Tuš vrata sklopiva s tuš-stijenom. Mogućnost ugradnje dodatnog profila K 30 za izvedbu nestandardnih dimenzija kabina po širini.
- Samostojeća tuš vrata sa sklopivim krilima sa tuš stenom. Mogućnost ugradnje dodatnog profila K 30 za izvođenje nestandardnih dimenzija kabina po širini.

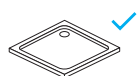
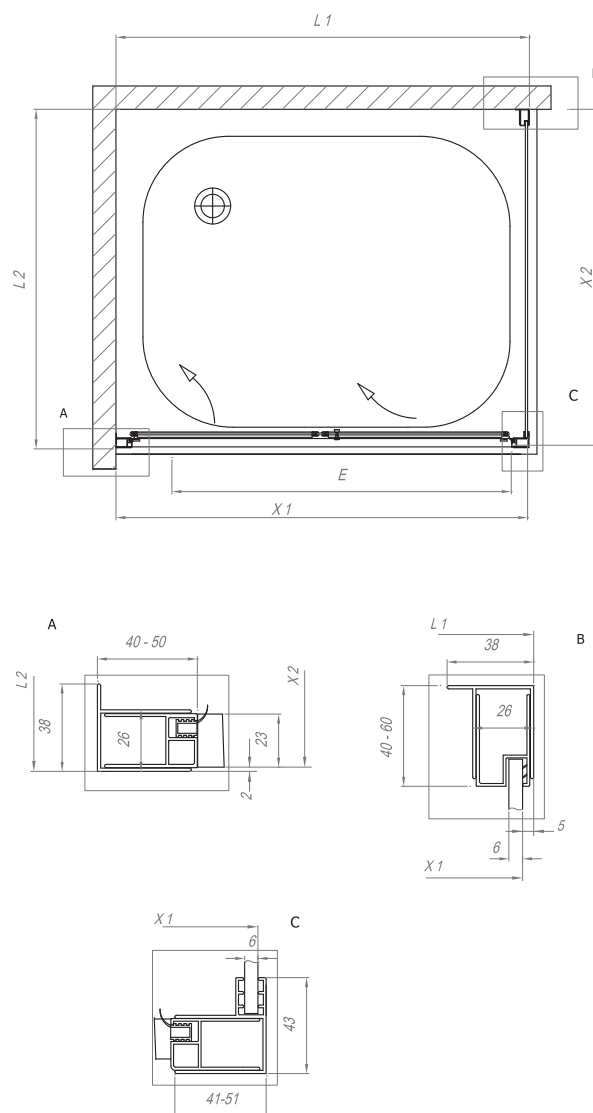

Menora Zero, Menora, Hopp, Tello, Moonwalk, Serra, Tobas, Capo, Canary, Drop, Flamenco, Evelin Tray Q,, Trin.

Luna UNI			L1	L2	X1	X2		E	
TVZ/S 90			880 - 900				1850	670	
TVZ/S 80			780 - 800				1850	570	
TSvZ 90				875 - 895		873 - 893	1850		
TSvZ 80				775 - 795		773 - 793	1850		

Luna UNI TVO/S 90, 80



194

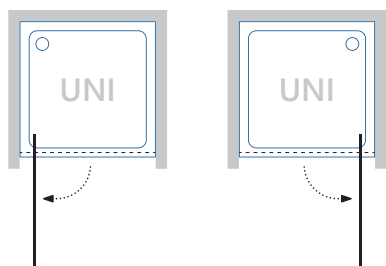

TVO/S 90, 80

- Samostojna tuš vrata, obračalna. Možnost vgradnje dodatnega profila K 25 za izvedbo nestandardnih dimenzij kabin po širini.
- Shower cabin, turnable. Optional K 25 profile for non-standard cabin widths.
- Tuš kabina, okretna. Mogućnost ugradnje dodatnog profila K 25 za izvedbu nestandardnih dimenzija kabina po širini.
- Tuš kabina, okretna. Mogućnost ugradnje dodatnog profila K 25 za izvođenje nestandardnih dimenzija kabina po širini.

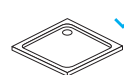
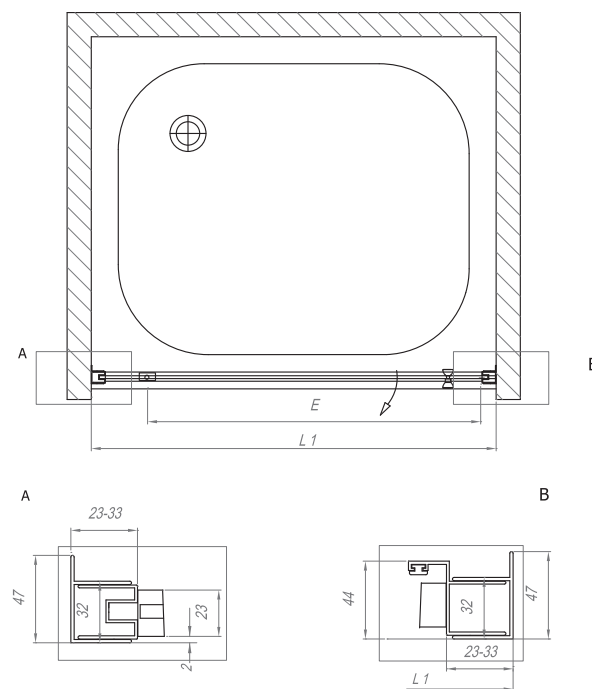

Menora Zero, Menora, Hopp, Tello, Moonwalk, Serra, Tobas, Capo, Canary, Drop, Flamenco, Evelin Tray Q, Trin.

Luna UNI			L1	L2	X1	X2		E	
TVO/S 90			880 - 900				1900	630	
TVO/S 80			780 - 800				1900	530	

Dodatni profili
Additional profiles
Dodatni profili
Dodatni profili

Dodatni profil za izvedbo nestandardnih dimenzij kabin po širini.

Različica s kompenzacijskim profilom K 30
 – za TV3D/S, TVZ/S

Additional profiles for fitting nonstandard dimension enclosure widths.

The variant with the compensational profile K 30 for TV3D/S, TVZ/S.

Dodatni profil za podešavanje izvan-standardnih dimenzija kabina po širini.

Varijanta s kompenzacijskim profilom K 30
 – za TV3D/S, TVZ/S

Dodatni profil za ugradnju nestandardnih dimenzija kabina po širini.

Varijanta sa kompenzacionim profilom K 30
 – za TV3D/S, TVZ/S

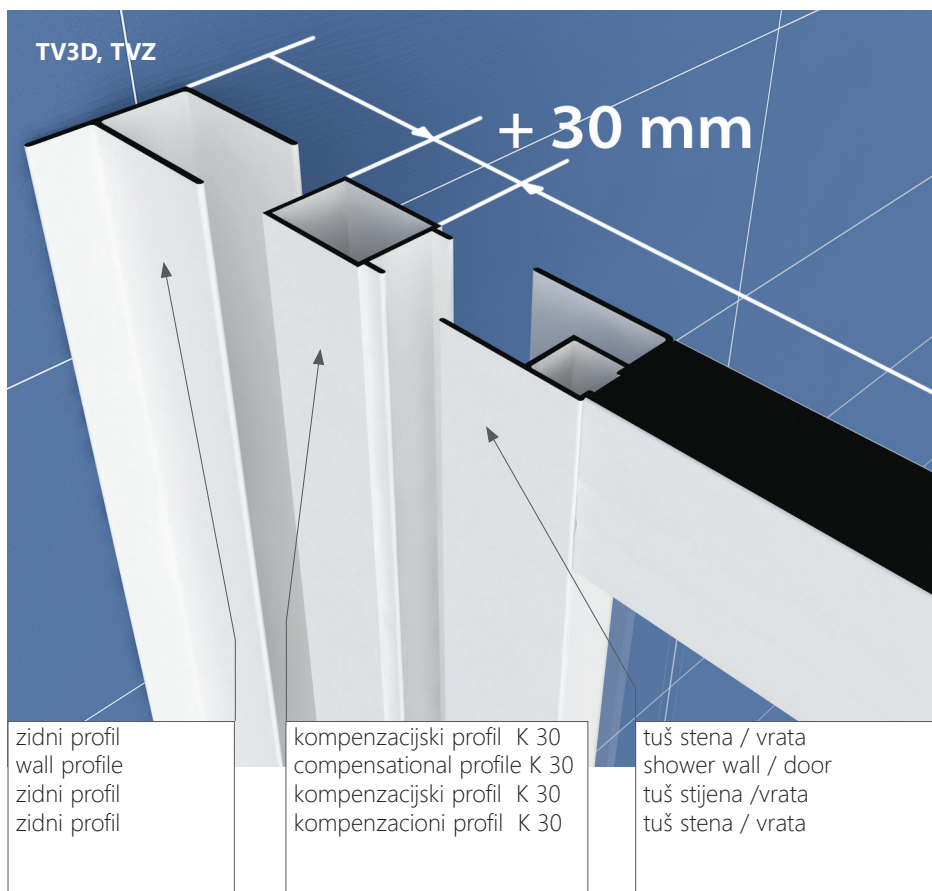

Dodatni profil za izvedbo nestandardnih dimenzij kabin po širini.

Različica s kompenzacijskim profilom K 25
 – za TVO/S

Additional profiles for fitting nonstandard dimension enclosure widths.

The variant with the compensational profile K 25 for TVO/S.





Dodatni profil za podešavanje izvan-standardnih dimenzija kabina po širini.

Varijanta s kompenzacijskim profilom K 25
 – za TVO/S

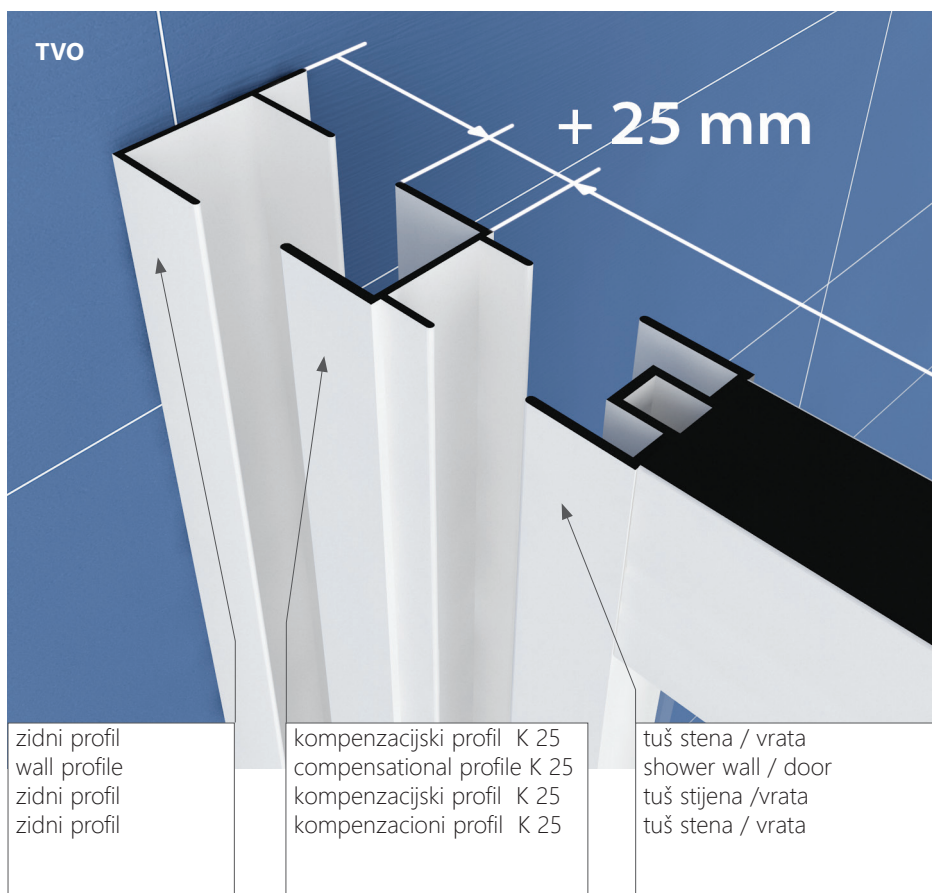
Dodatni profil za ugradnju nestandardnih dimenzija kabina po širini.

Varijanta sa kompenzacionim profilom K 25
 – za TVO/S



Tip /Type	Vrsta profila / Type of profile		
K 30 - TV3D/S, TVZ/S 	dodatni profil za TV3D/S, TVZ/S / additional profile for TV3D/S, TVZ/S	1850	30
K 25 - TVO/S 	dodatni profil za TVO/S / additional profile for TVO/S	1900	25





5 mm

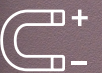

1850 mm



ECO QUAT





Družine tuš kabin in njihove značilnosti

A range of shower enclosures and their characteristics

Skupine tuš-kabina i njihove karakteristike

Asortiman tuš kabina i njihove karakteristike

197



5 mm KALJENO PROZORNO STEKLO

5 mm transparent tempered glass

5 mm kaljeno prozorno staklo

5 mm prozorno kaljeno staklo

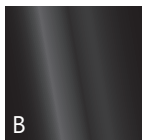

1850 mm BLACK (ČRNI) PROFILI, PRAŠNO LAKIRANJE

1850 mm BLACK profiles, powder coating

1850 mm BLACK (crni) profili, lakiranje prahom

1850 mm BLACK (crni) profili, suvo lakiranje



1850 mm SILVER PROFILI (SREBRNA GALVANSKA PREVLEKA)

1850 mm Silver Profiles (silver galvanised coating)

1850 mm Silver profili (srebrna galvanska prevlaka)

1850 mm Silver profili (srebrni galvanski premaz)



ZAPIRANJE Z MAGNETNIM PROFILOM

magnetic closure

zatvaranje s magnetnim profilom

zatvaranje pomoću magnetnog profila



SNEMLJIVA VRATNA KRILA OMOGOČAJO LAŽJE ČIŠČENJE

detachable door panels for easy cleaning

vratna krila na skidanje omogočuju lakše čiščenje

vratna krila sa mogućnošću skidanja omogućavaju lakše čiščenje

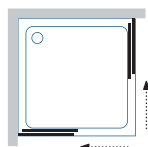

Eco Quat TKK

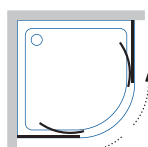

Eco Quat TKP

Eco Quat TKK 90, 80

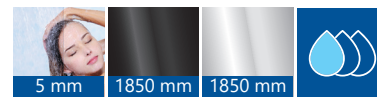

198

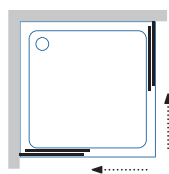

TKK 90, 80

- Kotna tuš kabina. Snemljivi vratni krili na krogličnih ležajjih, ki omogočajo lažje čiščenje.
- Corner shower enclosure. Door panels on ball bearings, detachable for easier cleaning.
- Kutna tuš kabina. Vratna krila na kugličnim ležajevima koja se mogu skidati i tako omogućavaju lakše čišćenje.
- Četvrtasta tuš kabina. Krila sa mogućnošću skidanja na kugličnim ležajevima koja omogućavaju lakše čišćenje.

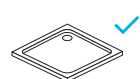
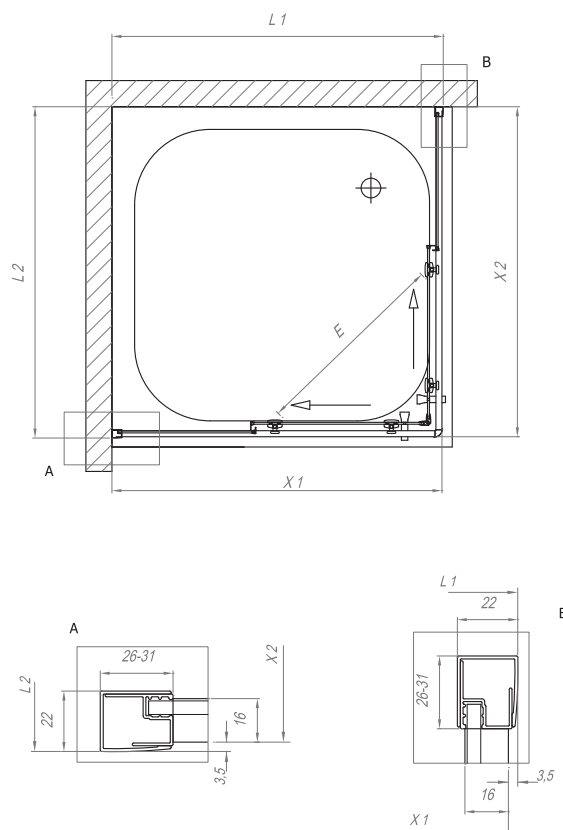

Menora Zero, Menora, Hopp, Tello, Moonwalk, Serra, Tobas, Capo, Canary, Drop, Flamenco, Evelin Tray Q, Trin.

Eco Quat			L1	L2	X1	X2		E	
TKK 90			875 - 880	875 - 880	872 - 877	872 - 877	1850	495	
TKK 80			775 - 780	775 - 780	772 - 777	772 - 777	1850	432	

Eco Quat TKP 90, 80

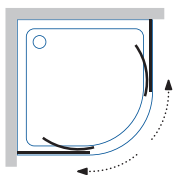
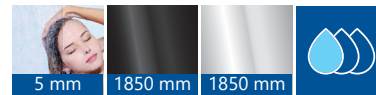

TKP 90, 80

- Polkrožna tuš kabina. Snemljivi vratni krili na krogličnih ležajjih, ki omogočajo lažje čiščenje.
- Semi-circular shower enclosure. Door panels on ball bearings, detachable for easier cleaning.
- Polukružna tuš kabina. Vratna krila na kugličnim ležajevima koja se mogu skidati i tako omogućavaju lakše čišćenje.
- Polukružna tuš kabina. Krila sa mogućnošću skidanja na kugličnim ležajevima koja omogućavaju lakše čišćenje.

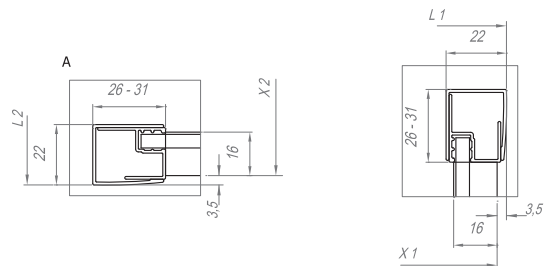
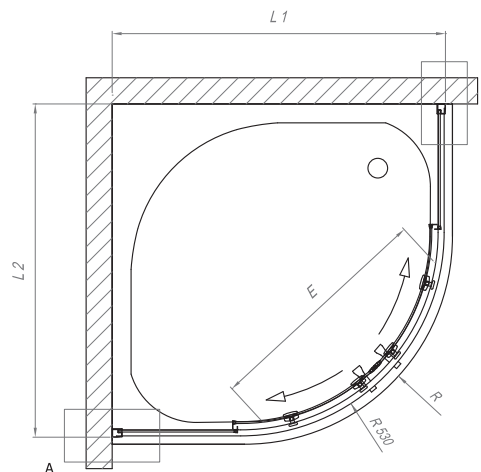

Menora R, Hopp R, Moonwalk R, Macarena, Drop R, Evelin Tray R, Ontex.

Eco Quat			L1	L2	X1	X2			E	
TKP 90			875 - 880	875 - 880	872 - 877	872 - 877	550	1850	570	
TKP 80			775 - 780	775 - 780	772 - 777	772 - 777	550	1850	450	



8 mm



1400 mm

POLARIS UNI



Družine tuš kabin in njihove značilnosti

A range of shower enclosures and their characteristics

Skupine tuš-kabina i njihove karakteristike

Asortiman tuš kabina i njihove karakteristike

201



8 mm KALJENO PROZORNO STEKLO

8 mm transparent tempered glass

8 mm kaljeno prozorno staklo

8 mm prozorno kaljeno staklo



1400 mm SILVER BRILL PROFILI (VISOKOPOLIRANA SREBRNA GALVANSKA PREVLEKA)

1400 mm Silver Brill Profiles (high gloss-polished silver galvanised coating)

1400 mm Silver Brill profili (visokopolirana srebrna galvanska prevlaka)

1400 mm Silver Brill profili (visokopolirani srebrni galvanski premaz)

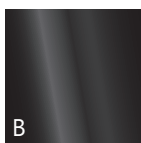

1400 mm BLACK (ČRNI) PROFILI, PRAŠNO LAKIRANJE

1400 mm BLACK profiles, powder coating

1400 mm BLACK (crni) profili, lakiranje prahom

1400 mm BLACK (crni) profili, suvo lakiranje



OPORA ZA STABILNOST STEKLA

glass stabilization support

potpora za stabilizacijo stakla

oslonac za stabilizacijo stakla

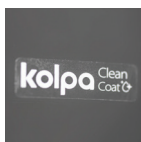

CLEAN COAT, ZAŠČITNI PREMAZ

Clean coat, protective coating

Clean coat, zaščitni premaz

Clean coat, zaščitni premaz



Polaris UNI BS

Polaris BS 80 UNI 1

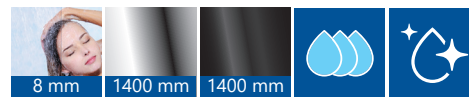

202

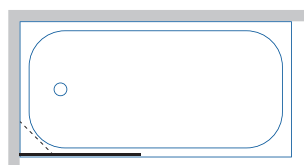

BS 80 UNI 1

- Enodelni krilni zaslon za kopalne kade. Možnost montaže levo ali desno. Zaslon je namenjen kopalnim kadem vseh dolžin.
- One-piece screen for bathtubs fixed. Left- and right-hand installation options. Suitable for all lengths of bathtubs.
- Jednodijelni krilni paravan za kupaonske kade. Mogućnost montaže lijevo ili desno. Paravan je primjeren za kupaonske kade svih dužina.
- Jednodielni tuš paravan za kadu. Mogućnost montaže levo ili desno. Tuš paravan je namenjen za kade svih dužina.

Opora stekla za BS 80 UNI 1
Glass support for BS 80 UNI 1
Držac stakla za BS 80 UNI 1 Potpora stakla za BS 80 UNI 1

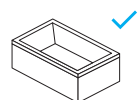
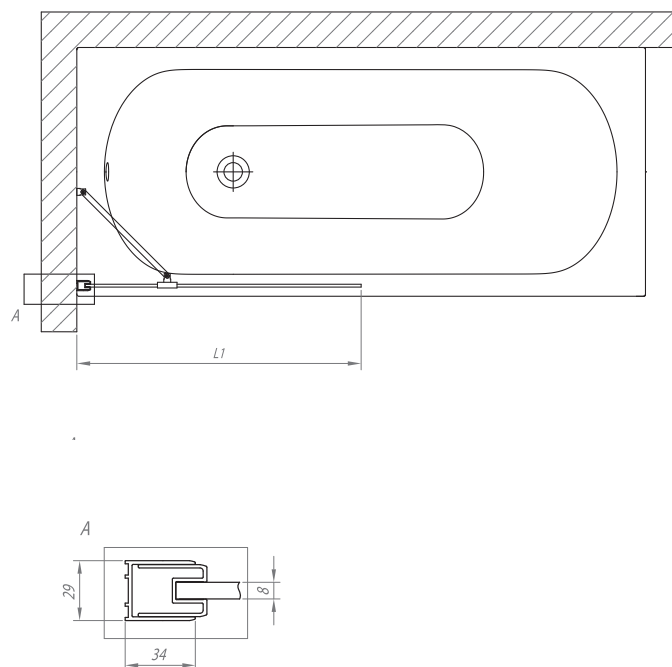

Polaris BS 80 UNI 1



204



6 mm



8 mm



1400 mm

ANDROMEDA UNI



Družine tuš kabin in njihove značilnosti

A range of shower enclosures and their characteristics

Skupine tuš-kabina i njihove karakteristike

Asortiman tuš kabina i njihove karakteristike

205



8/6 mm KALJENO PROZORNO STEKLO

8/6 mm transparent tempered glass

8/6 mm kaljeno prozirno staklo

8/6 mm prozirno kaljeno staklo



SBR

1400 mm SILVER BRILL PROFILI (VISOKOPOLIRANA SREBRNA GALVANSKA PREVLEKA)

1400 mm Silver Brill Profiles (high gloss-polished silver galvanised coating)

1400 mm Silver Brill profili (visokopolirana srebrna galvanska prevlaka)

1400 mm Silver Brill profili (visokopolirani srebrni galvanski premaz)

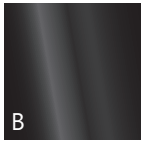

B

1400 mm BLACK (ČRNI) PROFILI, PRAŠNO LAKIRANJE

1400 mm BLACK profiles, powder coating

1400 mm BLACK (crni) profili, lakiranje prahom

1400 mm BLACK (crni) profili, suvo lakiranje



OPORA ZA STABILNOST STEKLA

glass stabilization support

potpora za stabilizacijo stakla

oslonac za stabilizacijo stakla



kolpa Clean Coat

CLEAN COAT, ZAŠČITNI PREMAZ

Clean coat, protective coating

Clean coat, zaščitni premaz

Clean coat, zaščitni premaz

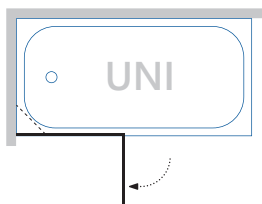

Andromeda BS UNI 1-2P

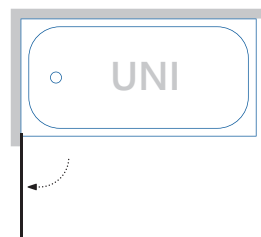

Andromeda BS UNI 1-1P

Andromeda BS 120 UNI 1-2P

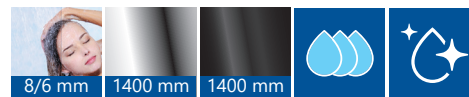

206

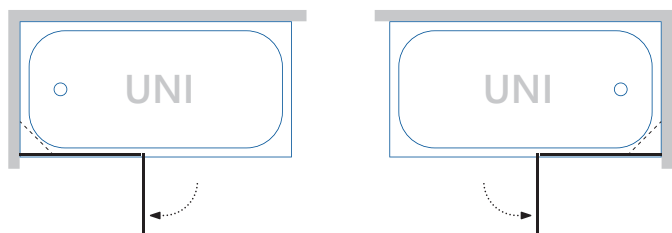

BS 120 UNI 1-2P

- Dvodelni krilni zaslon za kopalne kade na obračalnem profilu. Možnost montaže levo ali desno. Zaslon je namenjen ravnim kopalnim kadem vseh dolžin.
- Two-piece screen for bathtubs fixed on outer profile hinges. Left- and right-hand installation options. Suitable for all lengths of bathtubs.
- Dvodijelni krilni paravan za kupaonske kade na okretnom profilu. Mogućnost montaže lijevo ili desno. Paravan je primjeren za ravne kupaonske kade svih dužina.
- Dvodelni tuš paravan na profilu koji se okreće. Mogućnost montaže levo ili desno. Tuš paravan je namenjen za ravne kade svih dužina.

Opora stekla za BS 120 UNI 1-2P
Glass support for BS 120 UNI 1-2P
Držač stakla za BS 120 UNI 1-2P
Potpora stakla za BS 120 UNI 1-2P

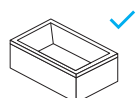
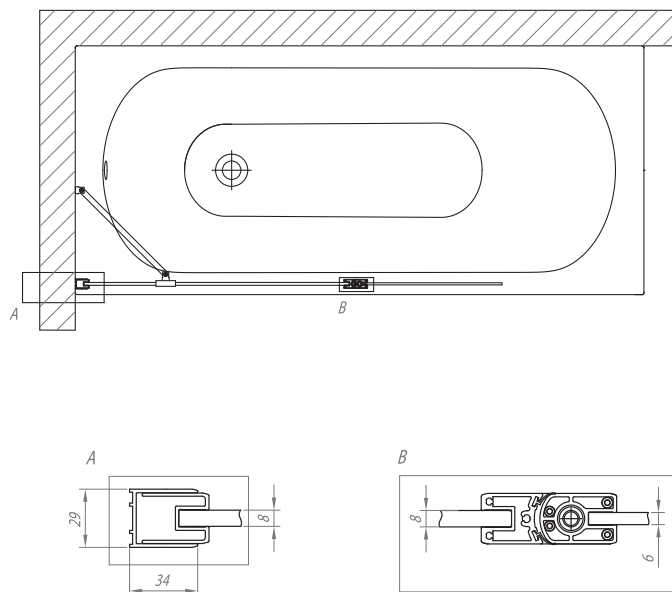

Andromeda BS 120 UNI 1-2P

Andromeda BS 80 UNI 1-1P

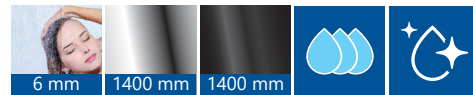

207

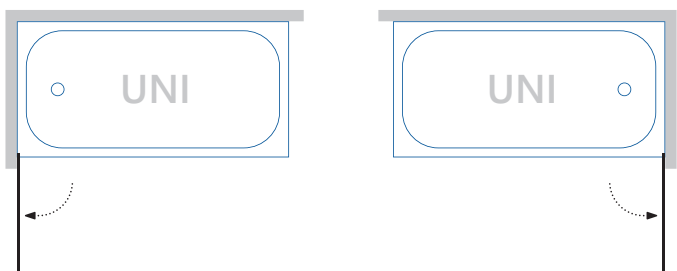

BS 80 UNI 1-1P

- Enodelni krilni zaslon za kopalne kade na obračalnem profilu. Možnost montaže levo ali desno. Zaslon je namenjen ravnim kopalnim kadem vseh dolžin.
- One-piece screen for bathtubs fixed on outer profile hinges. Left- and right-hand installation options. Suitable for all lengths of bathtubs.
- Jednodijelni krilni paravan za kupaonske kade na okretnom profilu. Mogućnost montaže lijevo i desno. Paravan je primjeren za ravne kupaonske kade svih dužina.
- Jednodielni tuš paravan na profilu koji se okreće. Mogućnost montaže levo ili desno. Tuš paravan je namenjen za ravne kade svih dužina.

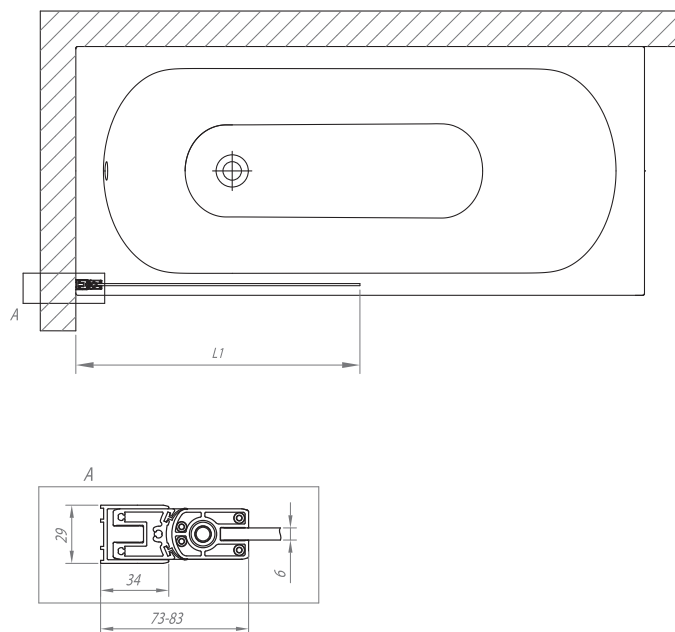

Andromeda BS 80 UNI 1-1P

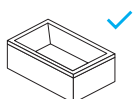



6 mm



1400 mm

SOLE UNI



Družine tuš kabin in njihove značilnosti

A range of shower enclosures and their characteristics

Skupine tuš-kabina i njihove karakteristike

Asortiman tuš kabina i njihove karakteristike

209



6 mm KALJENO PROZORNO STEKLO

6 mm transparent tempered glass

6 mm kaljeno prozorno staklo

6 mm prozorno kaljeno staklo



1400 mm SILVER PROFILI (SREBRNA GALVANSKA PREVLEKA)

1400 mm Silver Profiles (silver galvanised coating)

1400 mm Silver profili (srebrna galvanska prevlaka)

1400 mm Silver profili (srebrni galvanski premaz)



OPORA ZA STABILNOST STEKLA

glass stabilization support

potpora za stabilizacijo stakla

oslonac za stabilizacijo stakla

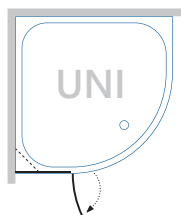

Sole UNI TP

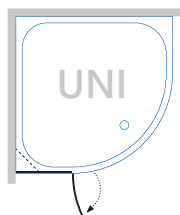

Sole UNI TP

Sole TP 102 UNI



210

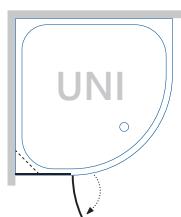

Dodatna ponudba: Opora stekla za TP (tp 102,104)

Dodatna ponuda: Glass support for TP (tp 102,104)

Dodatna ponuda: Držač stakla za TP (tp 102,104)

Dodatna ponuda: Potpora stakla za TP (tp 102,104)

TP 102 UNI

- Dvodelni krilni zaslon za kopalne kadi Royal, Divantne na obračalnom zidnom profilu.
- Prvo krilo na tečajih, preklopno na zunanjo stran, obe krili zložljivi na notranjo ali zunanjo stran.
- Two-piece screen for bathtubs Royal, Divantne fixed on outer wall profile hinges.
- One of the hinged wings can be opened outwards, while both folded together can be opened to either side..
- Dvodijelni krilni paravan za kupaonske kade Royal, Divantne na zidnom okretnom profilu.
- Prvo krilo je na šarkama koje se preklapaju na vanjsku stranu. Oba krila se mogu sklopiti na unutaranju ili vanjsku stranu.
- Dvodelni tuš paravan za kade Royal, Divante, na zidnom profilu koji se okreće.
- Prvo krilo je na šarkama, drugo se preklapa na spoljašnju, a oba su sklopiva na unutrašnju ili spoljašnju stranu.

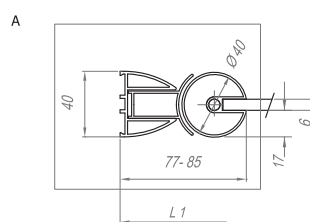
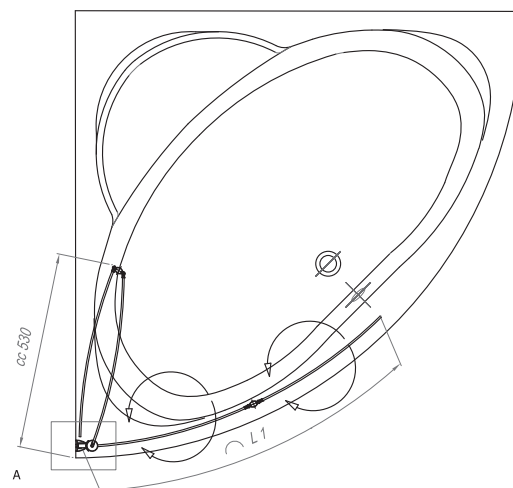

Sole TP 102 UNI

Sole TP 104 UNI



211

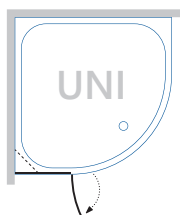

Dodatna ponudba: Opora stekla za TP (tp 102,104)

Dodatna ponuda: Glass support for TP (tp 102,104)

Dodatna ponuda: Držač stakla za TP (tp 102,104)

Dodatna ponuda: Potpora stakla za TP (tp 102,104)

TP 104 UNI

- Dvodelni krilni zaslon za kopalno kad Calando na obračalnem zidnem profilu.
- Prvo krilo na tečajih, preklopno na zunanjo stran, obe krili zložljivi na notranjo ali zunanjo stran.
- Two-piece screen for bathtubs Calando fixed on outer wall profile hinges.
- One of the hinged wings can be opened outwards, while both folded together can be opened to either side..
- Dvodijelni krilni paravan za kupaonsko kadu Calando na zidnom okretnom profilu.
- Prvo krilo je na šarkama koje se preklapaju na vanjsku stranu. Oba krila se mogu sklopiti na unutarnju ili vanjsku stranu.
- Dvodelni tuš paravan za kad Calando, na zidnom profilu koji se okreće.
- Prvo krilo je na šarkama, drugo se preklapa na spoljašnju, a oba su sklopiva na unutrašnju ili spoljašnju stranu.

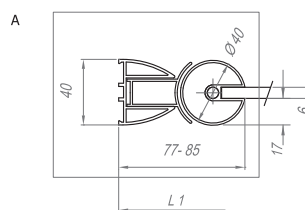
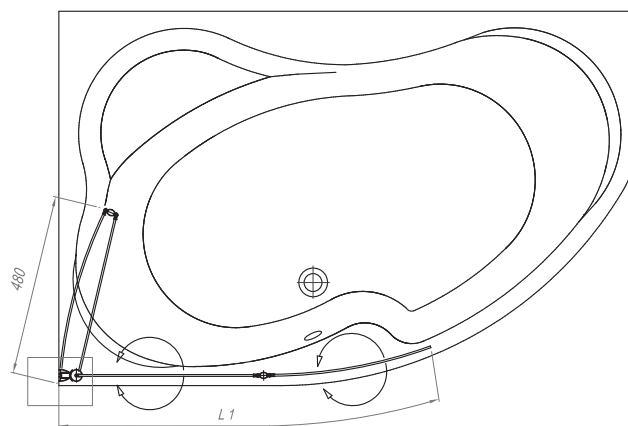

Sole TP 104 UNI



5 mm



1400 mm

QUAT UNI



Družine tuš kabin in njihove značilnosti

A range of shower enclosures and their characteristics

Skupine tuš-kabina i njihove karakteristike

Asortiman tuš kabina i njihove karakteristike



5 mm KALJENO PROZORNO STEKLO

5 mm transparent tempered glass

5 mm kaljeno prozirno staklo

5 mm prozirno kaljeno staklo



1400 mm SILVER PROFILI (SREBRNA GALVANSKA PREVLEKA)

1400 mm Silver Profiles (silver galvanised coating)

1400 mm Silver profili (srebrna galvanska prevlaka)

1400 mm Silver profili (srebrni galvanski premaz)

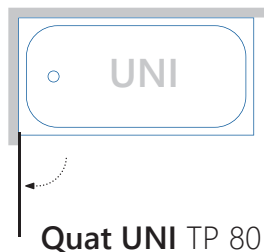

Quat TP 80 UNI



214

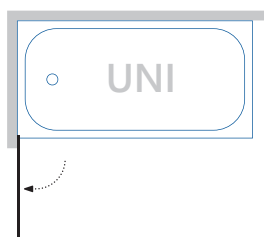

TP 80 UNI

- Enodelni krilni zaslon za kopalne kadi na obračalnem zidnem profilu. Možnost montaže levo ali desno. Zaslon je namenjen kopalnim kadem vseh dolžin.
- One-piece screen for bathtubs fixed on outer wall profile hinges. Left- and right-hand installation options. Suitable for all lengths of bathtubs.
- Jednodijelni krilni paravan za kupaonske kade na zidnom okretnem profilu. Mogućnost montaže lijevo ili desno. Paravan je primjeren za kupaonske kade svih dužina.
- Jednodielni tuš paravan na zidnom profilu koji se okreće. Mogućnost montaže levo ili desno. Tuš paravan je namenjen za kade svih dužina.

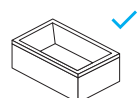
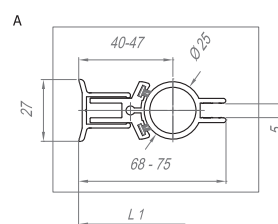
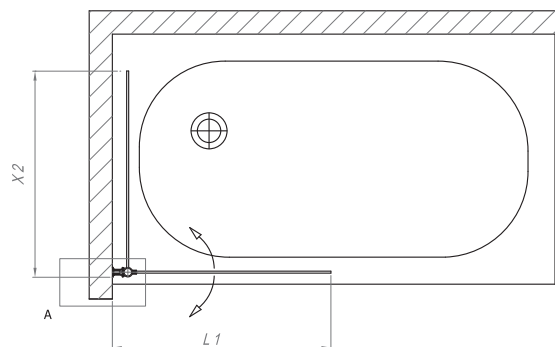

Quat TP 80 UNI





Dodatni profili pri tuš kabinah

Additional profiles for shower enclosures

Dodatni profili za tuš kabine

Dodatni profili kod tuš kabina



Imam nestandardne dimenzije kopalnice, kaj pa zdaj?

The dimensions of my bathroom are non-standard. What now?

Imam nestandardne dimenzije kupaonice, što sada?

Imam nestandardne dimenzije kupatila, šta da radim?

Za primere, ko prostor na razpolago za vgradnjo tuš kabin ni standardnih dimenzij, smo razvili dodatne kompenzacijske profile, s katerimi lahko prilagodimo standardne izdelke na željeno mero. Pri posameznih družinah tuš kabin lahko preverite, kateri izdelki ponujajo to možnost.

For the situations where the space available for the installation of a shower enclosure is of non-standard size, we have designed additional compensation Profiles allowing adjusting standard products to the desired dimensions. Verify compatible products for individual shower enclosure dimensions.

Za slučajeve kada prostor na raspolaganje za ugradnju tuš kabina nije standardnih dimenzija razvili smo dodatne kompenzacijske profile s kojima možemo prilagoditi standardne proizvode prema željenoj mjeri. Kod pojedinih duljina tuš kabina možete provjeriti koji proizvodi pružaju tu mogućnost.

Za slučajeve, kad prostor za ugradnju tuš kabina nije standardnih dimenzija, razvili smo dodatne kompenzacione profile pomoću kojih možemo da prilagodimo standardne proizvode na željenu meru. Kod pojedinih dužina tuš kabina možete proveriti koji proizvodi pružaju tu opciju.

Primer uporabe dodatnega profila

Example of using an additional profile

Primjer uporabe dodatnoga profila

Primer korišćenja dodatnog profila

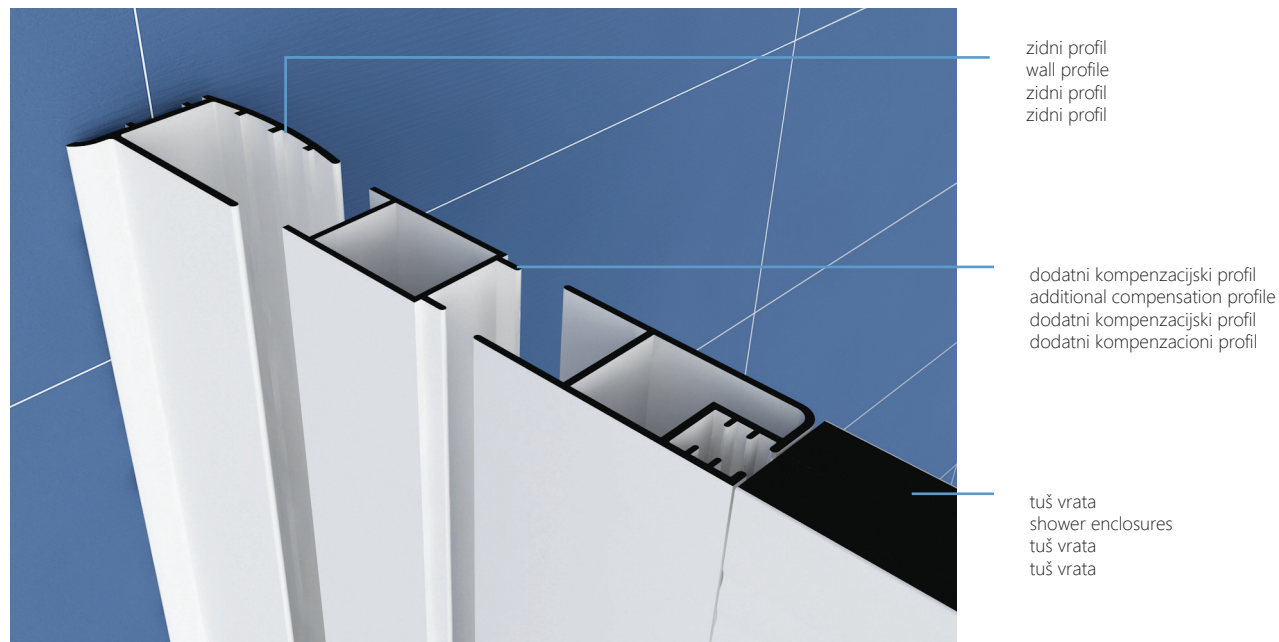



Tuš kabine posebnih dimenzij

Shower cabins with special dimensions

Tuš kabine posebnih dimenzija

Tuš kabine posebnih dimenzija

217



Kaj pa če v rednem programu ni rešitve za mojo tuš kabino?

What if I don't find a solution for my shower enclosure in your regular programme?

A što ako u redovnom programu nema rješenja za moju tuš kabinu?

Šta ako u redovnom programu nema rešenja za moju tuš kabinu?

V primeru, da vam naše standardne rešitve tuš kabin ne pridejo prav, vam lahko izdelamo rešitev po meri.
Za več informacij o tuš kabinah posebnih dimenzij obiščite spletno stran www.kolpasan.si.

In case our standard solutions of shower enclosures fail to meet your requirements, we can design a tailor-made solution for you.
For more information on non-standard shower cabins/enclosures, visit our www.kolpasan.si website.

U slučaju da vam naša standardna rešenja tuš kabina ne odgovaraju, možemo vam izraditi rešenje po mjeri.
Za više informacija o tuš kabinama posebnih dimenzija posjetite internetsku stranicu www.kolpasan.si.

www.kolpasan.si



U slučaju da vam naša standardna rešenja tuš kabina ne odgovaraju, možemo vam izraditi rešenje po mjeri.
Za više informacija o tuš kabinama posebnih dimenzija posetite internet stranu www.kolpasan.si.



Možnost prilagoditve višine

Height adjustment option

Mogućnost prilagodbe visine

Mogućnost prilagođavanja visine



Možnost prilagoditve širine

Width adjustment option

Mogućnost prilagodbe širine

Mogućnost prilagođavanja širine



Možnost prilagajanja naklonskega kota

Angle adjustment option

Mogućnost prilagođavanja nagibnog kuta

Mogućnost prilagođavanja nagiba



Možnost prilagajanja oblike

Shape adjustment option

Mogućnost prilagođavanja oblika

Mogućnost prilagođavanja oblika



Možnosti izbire barve profila

Stud colour options

Mogućnost odabira boje profila

Mogućnost izbora boje profila



Info

Za zelo zahtevne primere tuš kabin, ki jih ne najdete v tej ponudbi, lahko za kupca poiščemo individualno rešitev.

When no suitable solution for complex shower cabins can be found in this catalogue, we'll be happy to fix an individual solution for you.

Za vrlo složene slučajeve tuš kabina koje niste pronašli u ovoj ponudi, za kupca možemo pronaći i individualno rješenje.

Za izuzetno komplikovane slučajeve tuš kabina, ako ih niste našli u ovoj ponudi, možemo za kupca potražiti individualno rešenje.