

VOLUMEN (l)  
VOLUMEN (l)

MAX. OBREMENITEV (Kg)  
MAX. OBTEREČENJE (Kg)

OBREMENITEV TAL (Kg/m<sup>2</sup>)  
OBTEREČENJE PODA (Kg/m<sup>2</sup>)

165

310







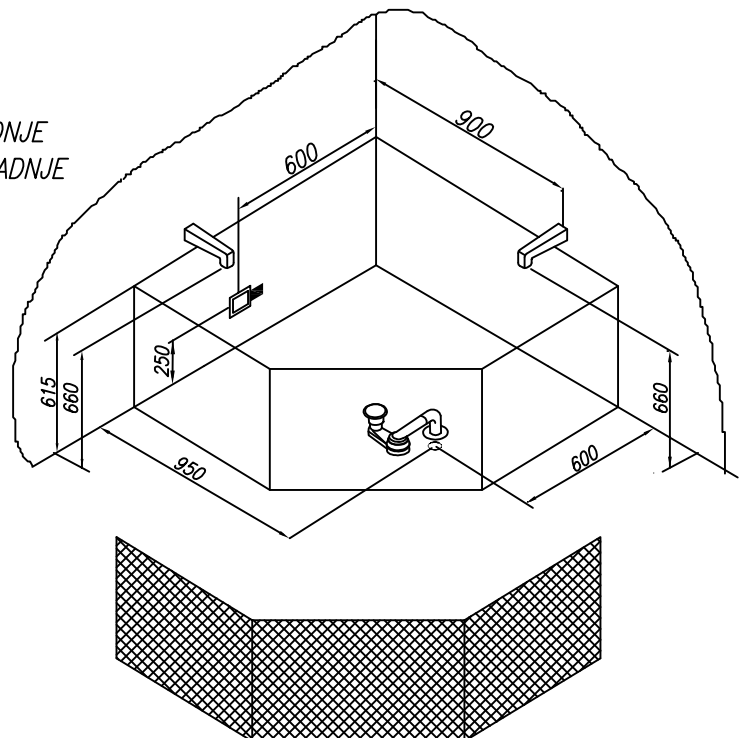



250

- - Prostor za el. vodnik 3 x 2,5 mm<sup>2</sup> dolžine cca 1m.
- Mjesto za el. vodnik 3 x 2,5 mm<sup>2</sup> dužine cca 1m.
- - Prostor za el. vodnik 1 x 6 mm<sup>2</sup> za ozemljitev, dolžine cca 1,5m.
- Mjesto za el. vodnik 1 x 6 mm<sup>2</sup> za ozemljenje, dužine cca 1,5m.
- - Prostor za odtok ø 50 mm
- Mjesto za odtok ø 50 mm
- ▣ - Opcija-obloga
- Opcija-obloga

PREDLOG VGRADNJE  
PRIJEDLOG UGRADNJE



Priporočena prelivna garnitura Preporuka prelivne garniture	PAL 650
Priporočila za vgradnjo kadi brez obloge Preporuka za ugradnjo kade brez obloge	Nr. MK 02
Priporočila za montažo kadi z oblogo Preporuka za ugradnjo kade sa oblogom	Nr. MK 01
Opcija podnožja kadi za vgradnjo Varianta postolja za kade brez obloge	Nr. MK 07 1001/L
Opcija podnožja kadi z oblogo Varianta postolja za kade sa oblogom	Nr. MK 27 CE 120-140

- |  |  |   |  |  |
|--|--|---|--|--|
|  - VODNA ČRPALKA<br>- CRPKA ZA VODU        |  - VODNE ŠOBE<br>- VODENE MLAZNICE  |  - REGULATOR ZRAKA<br>- REGULATOR ZRAKA        |  - ELEKTRONSKA STIKALA<br>- ELEKTRONSKI PREKIDAČI         |  - ARMATURA IN TUŠ ROČICA<br>- PIPA I TUŠ                 |
|  - ZRAČNI KOMPRESOR<br>- ZRAČNI KOMPRESOR |  - ZRAČNA ŠOBA<br>- ZRAČNA MLAZNICA |  - PNEVMATSKO STIKALO<br>- PNEVMATSKI PREKIDAČ |  - LUČ ALI CHROMOTERAPIJA<br>- SVJETLO ILI CHROMOTERAPIJA |  - PREKLOPNIK ZA MIKROŠOBE<br>- PREKIDAČ ZA MIKROMLAZNICE |

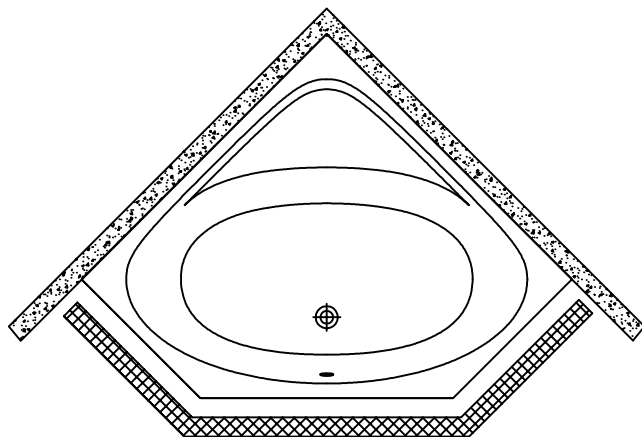
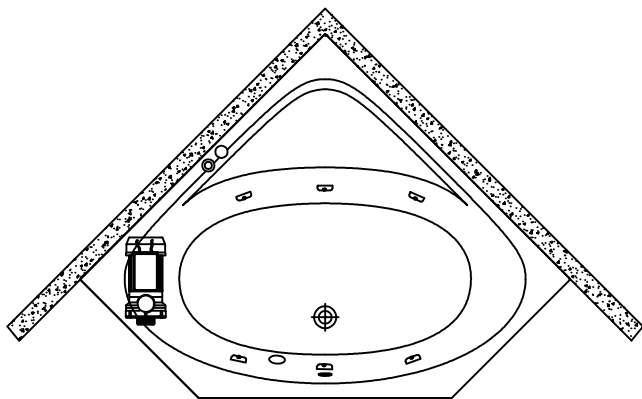

VODNI MASAŽNI SISTEM 1

- VODNA ČRPALKA P= 800W
- PNEVMATSKO STIKALO
- 6 VODNIH ŠOB
- REGULATOR ZRAKA

VODNI MASAŽNI SISTEM 1

- CRPKA ZA VODU P= 800W
- PNEVMATSKI PREKIDAČ
- 6 MLAZNICA ZA VODU
- REGULATOR ZRAKA

- OPCIJA OBLOGA KADI

- OPCIJA OBLOGA KADE

